

3 TERMINAL FILTERS

- FTC SERIES -

FEATURES

- Reduction in ESR, ESL and impedance due to the feed through structure
- Superior attenuation characteristic in wide bandwidth
- Contributes to reduction in the number of decoupling MLCCs
- Available for large current (2 to 6A)

APPLICATIONS

- EMC countermeasures and decoupling applications in power lines for communication terminal devices such as smartphones, AV and information devices

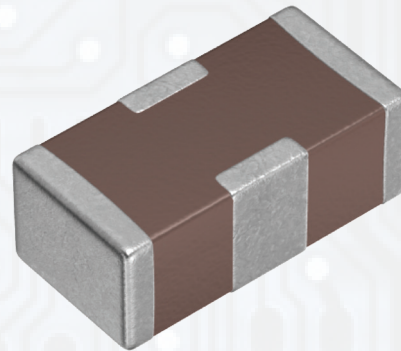

PART NUMBERING

FTC	10	ST	226	M	6R3	NT
PRODUCT TYPE	L X W DIMENSIONS	INTERNAL CODE	NOMINAL CAPACITANCE	CAPACITANCE TOLERANCE	RATED VOLTAGE	PACKAGING
Filter	04 - 1.0 X 0.5 10 - 1.6 X 0.8 21 - 2.0 X 1.2 31 - 3.2 X 1.6	ST - Standard Type TK - Thickness 0.8mm LE - Low ESL Type	104 - 100,000pF 105 - 1.0µF 435 - 4.3µF 226 - 22µF	M - ±20%	4R0 - 4V 6R3 - 6.3V 10 - 10V 16 - 16V	NT - Tape and Reel 7" diameter NTD - Tape and Reel 13" Diameter

PRODUCT STRUCTURE

- Feed-through structure that direct current passes inside the component

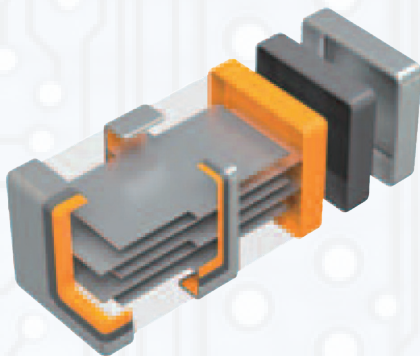

- Sn
- Ni
- Cu

EQUIVALENT CIRCUIT

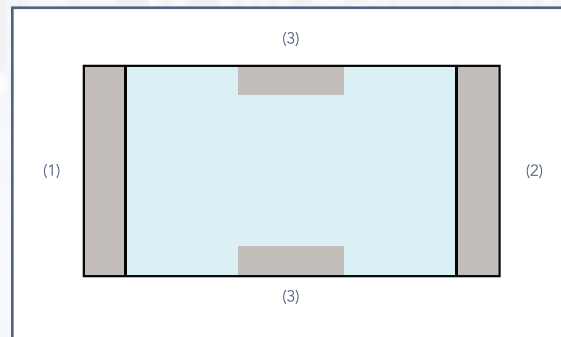
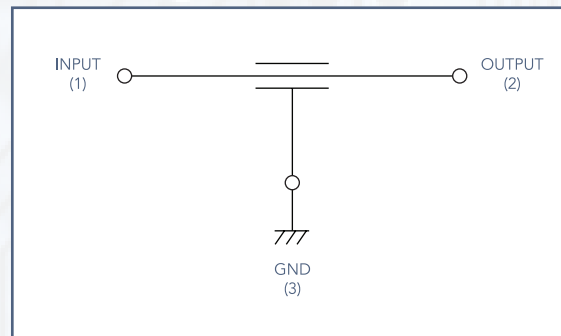

ELECTRICAL CHARACTERISTICS

- Characteristics Specification Table

PART NUMBER	INSERTION LOSS 40dB BANDWIDTH (MHZ)	RATED VOLTAGE Edc (V)	RATED CURRENT Idc (A)	DC RESISTANCE (MAX) Rdc (MΩ)	OPERATING TEMPERATURE RANGE (°C)	STORAGE TEMPERATURE RANGE (AFTER MOUNT) (°C)
FTC04ST435M4R0NT	0.3 to 1700	4	2	12	-55 to +85	-55 to +85
FTC04ST105M6R3NT-1	1 to 2600	6.3	2	30	-55 to +125	-55 to +125
FTC04ST105M6R3NT	0.8 to 1000	6.3	3	12	-55 to +105	-55 to +105
FTC04ST105M4R0NT	0.8 to 1800	4	3	12	-55 to +105	-55 to +105
FTC04ST474M6R3NT	2 to 1700	6.3	3	30	-55 to +105	-55 to +105
FTC04ST224M10NT	4 to 1300	10	3	30	-55 to +105	-55 to +105
FTC04ST104M16NT	9 to 1300	16	3	30	-55 to +105	-55 to +105

- The rated current depends on the operating temperature. For details, refer to RATED CURRENT DERATING graph below.
- The maximum operating temperature includes capacitor self-heating of up to 20°C.

ELECTRICAL CHARACTERISTICS GRAPH

- Insertion Loss Vs Frequency

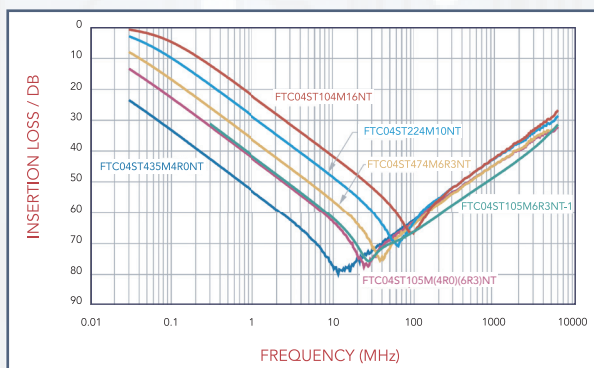

- Rated Current Derating

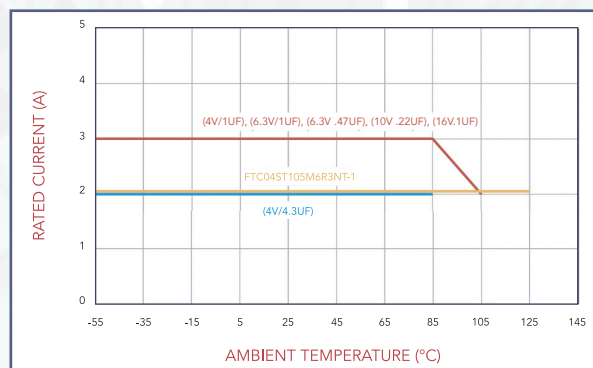

SHAPES & DIMENSIONS

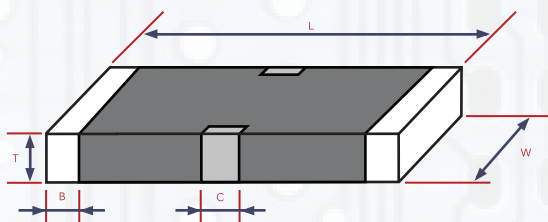

RECOMMENDED LAND PATTERN

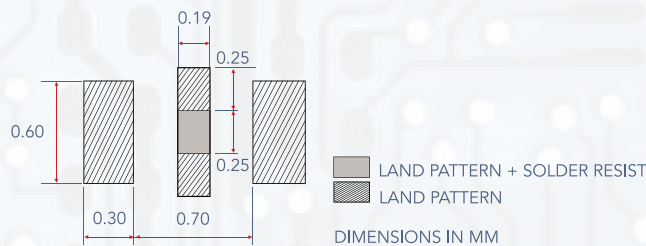

PART NUMBER	L (MM)	W (MM)	T (MM)	B (MM)	C (MM)	REEL SIZE (MM)	PACKAGING QTY (PCS./REEL)
FTC04ST435M4R0NT	1.05±0.05	0.65±0.05	0.45±0.05	0.09 min.	0.30±0.10	ø178	10,000
FTC04ST105M6R3NT-1	1.00±0.20	0.50±0.20	0.40±0.10	0.18±0.10	0.30±0.10	ø178	10,000
FTC04ST105M6R3NT	1.00±0.05	0.55±0.05	0.30±0.05	0.09 min.	0.30±0.10	ø178	10,000
FTC04ST105M4R0NT	1.00±0.05	0.55±0.05	0.30±0.05	0.09 min.	0.30±0.10	ø178	10,000
FTC04ST474M6R3NT	1.00±0.05	0.55±0.05	0.30±0.05	0.09 min.	0.30±0.10	ø178	10,000
FTC04ST224M10NT	1.00±0.05	0.55±0.05	0.30±0.05	0.09 min.	0.30±0.10	ø178	10,000
FTC04ST104M16NT	1.00±0.05	0.55±0.05	0.30±0.05	0.09 min.	0.30±0.10	ø178	10,000





ELECTRICAL CHARACTERISTICS

FTC10ST

- Characteristics Specification Table

PART NUMBER	INSERTION LOSS 40dB BANDWIDTH (MHZ)	RATED VOLTAGE Edc (V)	RATED CURRENT Idc (A)	DC RESISTANCE (MAX) Rdc (MΩ)	OPERATING TEMPERATURE RANGE (°C)	STORAGE TEMPERATURE RANGE (AFTER MOUNT) (°C)
FTC10ST475M6R3NT	0.2 to 1500	6.3	4	12	-55 to +85	-55 to +85
FTC10ST105M6R3NT	0.8 to 1600	6.3	4	12	-55 to +105	-55 to +105
FTC10ST474M6R3NT	2 to 1100	6.3	4	30	-55 to +125	-55 to +125
FTC10ST224M6R3NT	3 to 1800	6.3	4	30	-55 to +125	-55 to +125
FTC10ST104M16NT	7 to 1100	16	4	30	-55 to +125	-55 to +125

- The rated current depends on the operating temperature. For details, refer to RATED CURRENT DERATING graph below.
- The maximum operating temperature includes capacitor self-heating of up to 20°C.



ELECTRICAL CHARACTERISTICS GRAPH

- Insertion Loss Vs Frequency

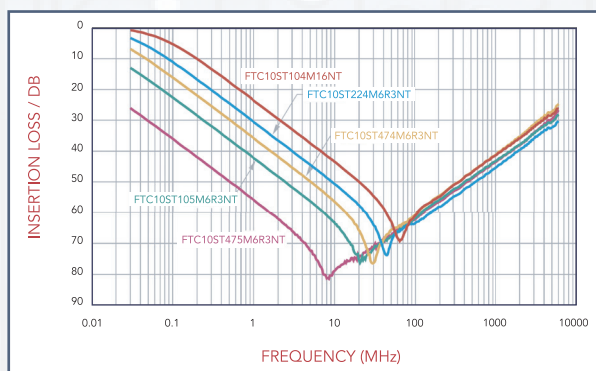

- Rated Current Derating

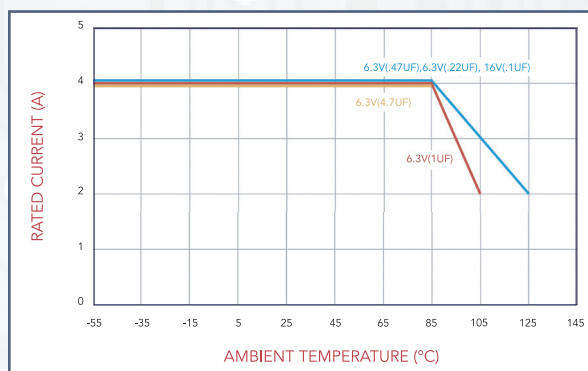

SHAPES & DIMENSIONS

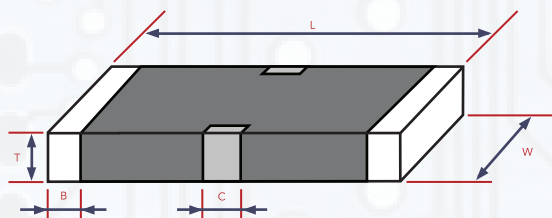

RECOMMENDED LAND PATTERN

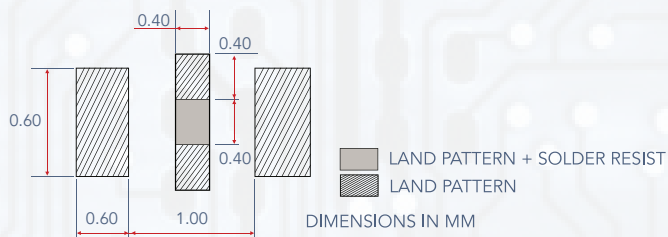

PART NUMBER	L (MM)	W (MM)	T (MM)	B (MM)	C (MM)	REEL SIZE (MM)	PACKAGING QTY (PCS./REEL)
FTC10ST475M6R3NT	1.60±0.20	0.80±0.10	0.60±0.10	0.25±0.15	0.40±0.10	φ178	4,000
FTC10ST105M6R3NT	1.60±0.20	0.80±0.10	0.60±0.10	0.25±0.15	0.40±0.10	φ178	4,000
FTC10ST474M6R3NT	1.60±0.20	0.80±0.10	0.60±0.10	0.25±0.15	0.40±0.10	φ178	4,000
FTC10ST224M6R3NT	1.60±0.20	0.80±0.10	0.60±0.10	0.25±0.15	0.40±0.10	φ178	4,000
FTC10ST104M16NT	1.60±0.20	0.80±0.10	0.60±0.10	0.25±0.15	0.40±0.10	φ178	4,000

ELECTRICAL CHARACTERISTICS

- Characteristics Specification Table

PART NUMBER	INSERTION LOSS 40dB BANDWIDTH (MHZ)	RATED VOLTAGE E _{dc} (V)	RATED CURRENT I _{dc} (A)	DC RESISTANCE (MAX) R _{dc} (MΩ)	OPERATING TEMPERATURE RANGE (°C)	STORAGE TEMPERATURE RANGE (AFTER MOUNT) (°C)
FTC10TK106M6R3NT	0.3 to 1700	6.3	4	10	-55 to +125	-55 to +125
FTC10TK225M6R3NT	0.4 to 1500	6.3	4	12	-55 to +85	-55 to +85
FTC10TK105M6R3NT	0.7 to 1100	6.3	4	12	-55 to +105	-55 to +105
FTC10TK225M10NT	0.4 to 1500	10	4	10	-40 TO 85	-40 TO 85

- The rated current depends on the operating temperature. For details, refer to RATED CURRENT DERATING graph below.
- The maximum operating temperature includes capacitor self-heating of up to 20°C.

ELECTRICAL CHARACTERISTICS GRAPH

- Insertion Loss Vs Frequency

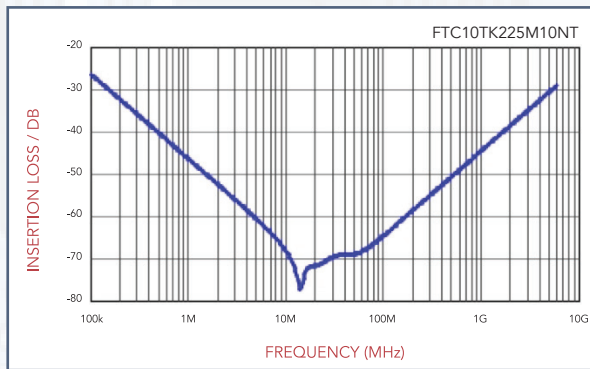
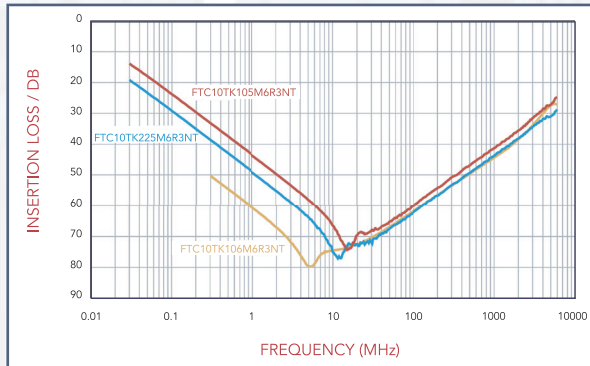

- Rated Current Derating

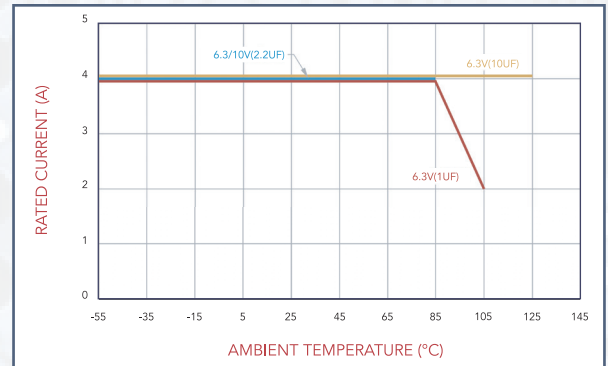

SHAPES & DIMENSIONS

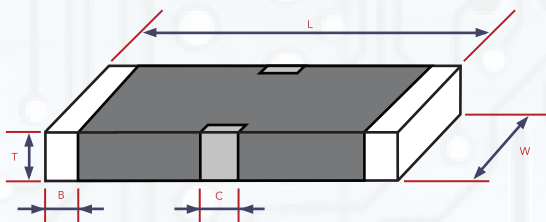

RECOMMENDED LAND PATTERN

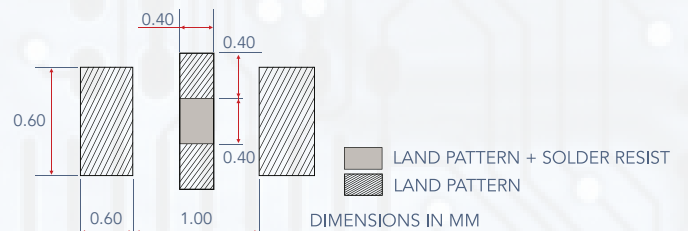

PART NUMBER	L (MM)	W (MM)	T (MM)	B (MM)	C (MM)	REEL SIZE (MM)	PACKAGING QTY (PCS./REEL)
FTC10TK106M6R3NT	1.60+0.30,-0.10	0.80+0.30,-0.10	0.80+0.30,-0.10	0.25±0.20	0.40±0.20	ø178	3,000
FTC10TK225M6R3NT	1.60±0.20	0.80±0.10	0.80±0.10	0.25±0.15	0.40±0.10	ø178	4,000
FTC10TK105M6R3NT	1.60±0.20	0.80±0.10	0.80±0.10	0.25±0.15	0.40±0.10	ø178	4,000
FTC10TK225M10NT	1.6+/-0.20	0.8+/-0.10	0.80+/-0.10	0.25+/-0.15	0.40+/-0.10	ø178	4,000





ELECTRICAL CHARACTERISTICS

FTC10LE

- Characteristics Specification Table

PART NUMBER	INSERTION LOSS 40dB BANDWIDTH (MHZ)	RATED VOLTAGE Edc (V)	RATED CURRENT Idc (A)	DC RESISTANCE (MAX) Rdc (MΩ)	OPERATING TEMPERATURE RANGE (°C)	STORAGE TEMPERATURE RANGE (AFTER MOUNT) (°C)
FTC10LE475M6R3NT	0.2 to 2700	6.3	4	12	-55 to +85	-55 to +85
FTC10LE105M6R3NT	0.8 to 2400	6.3	4	30	-55 to +105	-55 to +105
FTC10LE474M6R3NT	2 to 2400	6.3	4	30	-55 to +125	-55 to +125

- The rated current depends on the operating temperature. For details, refer to RATED CURRENT DERATING graph below.
- The maximum operating temperature includes capacitor self-heating of up to 20°C.



ELECTRICAL CHARACTERISTICS GRAPH

- Insertion Loss Vs Frequency

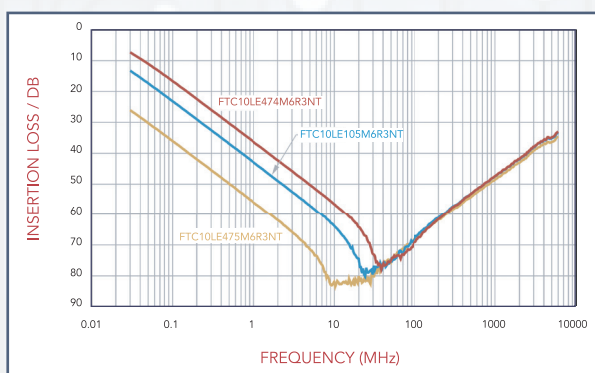

- Rated Current Derating

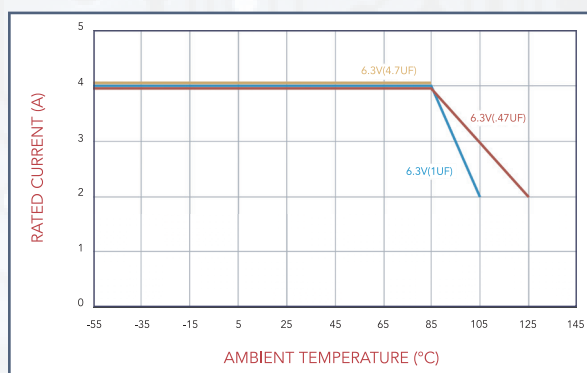

SHAPES & DIMENSIONS

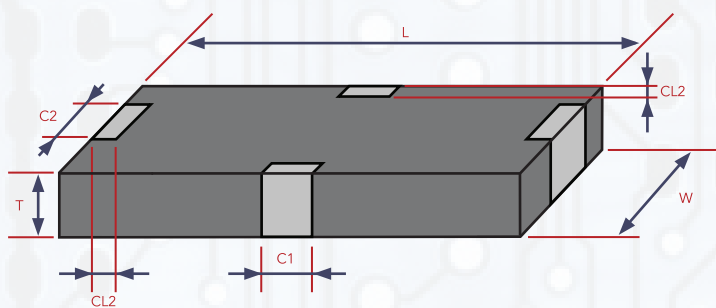

RECOMMENDED LAND PATTERN

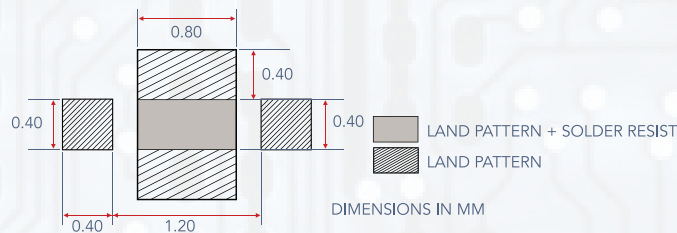

PART NUMBER	L (MM)	W (MM)	T (MM)	C1 (MM)	CL1 (MM)	C2 (MM)	CL2 (MM)	REEL SIZE (MM)	PACKAGING QTY (PCS./REEL)
FTC10 LE475M6R3NT	1.60±0.10	0.80±0.10	0.60±0.10	0.80+0.20,-0.10	0.15±0.10	0.40±0.10	0.15±0.10	ø178	4,000
FTC10LE105M6R3NT	1.60±0.10	0.80±0.10	0.60±0.10	0.80+0.20,-0.10	0.15±0.10	0.40±0.10	0.15±0.10	ø178	4,000
FTC10LE474M6R3NT	1.60±0.10	0.80±0.10	0.60±0.10	0.80+0.20,-0.10	0.15±0.10	0.40±0.10	0.15±0.10	ø178	4,000

ELECTRICAL CHARACTERISTICS

- Characteristics Specification Table

PART NUMBER	INSERTION LOSS 40dB BANDWIDTH (MHZ)	RATED VOLTAGE E _{dc} (V)	RATED CURRENT I _{dc} (A)	DC RESISTANCE (MAX) R _{dc} (MΩ)	OPERATING TEMPERATURE RANGE (°C)	STORAGE TEMPERATURE RANGE (AFTER MOUNT) (°C)
FTC21ST226M6R3NT	0.04 to 1700	6.3	4	5	-55 to +85	-55 to +85
FTC21ST105M10NT	0.7 to 1600	10	4	12	-55 to +85	-55 to +85
FTC21ST474M16NT	2 to 1200	16	2	30	-55 to +125	-55 to +125

- The rated current depends on the operating temperature. For details, refer to RATED CURRENT DERATING graph below.
- The maximum operating temperature includes capacitor self-heating of up to 20°C.

ELECTRICAL CHARACTERISTICS GRAPH

- Insertion Loss Vs Frequency

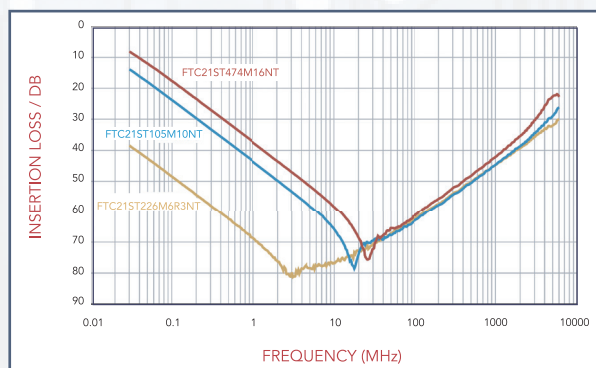

RECOMMENDED LAND PATTERN

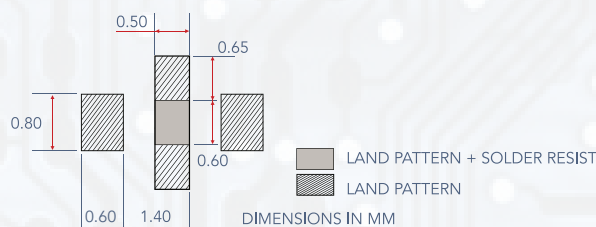

SHAPES & DIMENSIONS

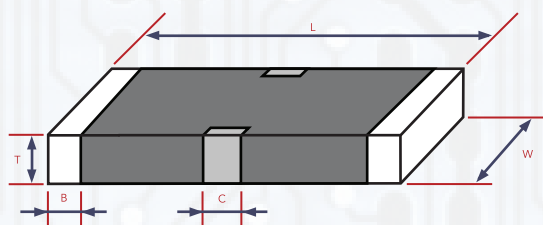

PART NUMBER	L (MM)	W (MM)	T (MM)	B (MM)	C (MM)	REEL SIZE (MM)	PACKAGING QTY (PCS./REEL)
FTC21ST226M6R3NT	2.00±0.20	1.25±0.20	0.85±0.15	0.30±0.10	0.45±0.15	ø178	4,000
FTC21ST105M10NT	2.00±0.20	1.25±0.20	0.85±0.15	0.30±0.10	0.45±0.15	ø178	4,000
FTC21ST474M16NT	2.00±0.20	1.25±0.20	0.85±0.15	0.30±0.10	0.45±0.15	ø178	4,000





ELECTRICAL CHARACTERISTICS

FTC31ST

- Characteristics Specification Table

PART NUMBER	INSERTION LOSS 40dB BANDWIDTH (MHZ)	RATED VOLTAGE Edc (V)	RATED CURRENT Idc (A)	DC RESISTANCE (MAX) Rdc (MΩ)	OPERATING TEMPERATURE RANGE (°C)	STORAGE TEMPERATURE RANGE (AFTER MOUNT) (°C)
FTC31ST226M6R3NT	0.3 to 1300	6.3	6	5	-55 to +125	-55 to +125
FTC31ST105M16NT	0.7 to 1200	16	2	40	-55 to +125	-55 to +125
FTC31ST474M16NT	2 to 1000	16	2	40	-55 to +125	-55 to +125
FTC31ST224M16NT	3 to 700	16	2	40	-55 to +125	-55 to +125

- The rated current depends on the operating temperature. For details, refer to RATED CURRENT DERATING graph below.
- The maximum operating temperature includes capacitor self-heating of up to 20°C.



ELECTRICAL CHARACTERISTICS GRAPH

- Insertion Loss Vs Frequency

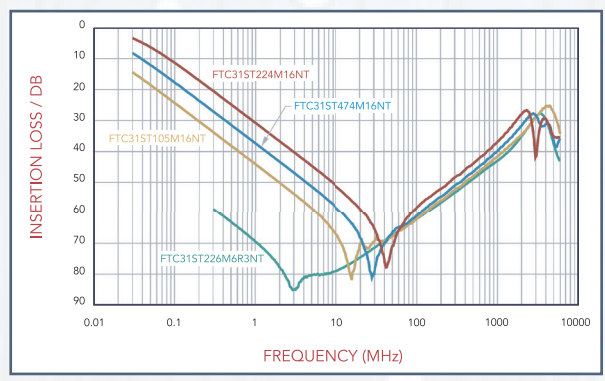

RECOMMENDED LAND PATTERN

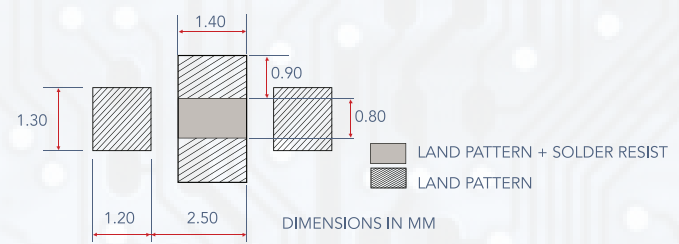

SHAPES & DIMENSIONS

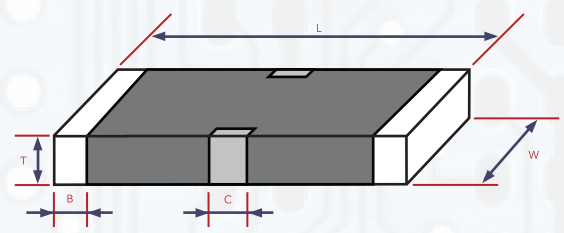

PART NUMBER	L (MM)	W (MM)	T (MM)	B (MM)	C (MM)	REEL SIZE (MM)	PACKAGING QTY (PCS./REEL)
FTC31ST226M6R3NT	3.20±0.20	1.60±0.20	1.30±0.20	0.40±0.30	1.10±0.40	ø178	2,000
FTC31ST105M16NT	3.20±0.20	1.60±0.20	1.30±0.20	0.40±0.30	0.95±0.25	ø178	2,000
FTC31ST474M16NT	3.20±0.20	1.60±0.20	1.30±0.20	0.40±0.30	0.95±0.25	ø178	2,000
FTC31ST224M16NT	3.20±0.20	1.60±0.20	1.30±0.20	0.40±0.30	0.95±0.25	ø178	2,000



REMINDEES FOR USING THESE PRODUCTS

Before using these products, be sure to request the delivery specifications.

SAFETY REMINDERS

Please pay sufficient attention to the warnings for safe designing when using this products.



REMINDEES

- The products listed on this catalog are intended for use in general electronic equipment (AV equipment, telecommunications equipment, home appliances, amusement equipment, computer equipment, personal equipment, office equipment, measurement equipment, industrial robots) under a normal operation and use condition.
- The products are not designed or warranted to meet the requirements of the applications listed below, whose performance and/or quality require a more stringent level of safety or reliability, or whose failure, malfunction or trouble could cause serious damage to society, person or property.
- If you intend to use the products in the applications listed below or if you have special requirements exceeding the range or conditions set forth in the each catalog, please contact us.

Aerospace/aviation equipment

Transportation equipment (cars, electric trains, ships, etc.)

Medical equipment (excepting Pharmaceutical Affairs Law classification Class1,2)

Power-generation control equipment

Atomic energy-related equipmen

Seabed equipment

Transportation control equipment

When designing your equipment even for general-purpose applications, you are kindly requested to take into consideration securing protection circuit/device or providing backup circuits in your equipment.

Public information-processing equipment

Military equipment

Electric heating apparatus, burning equipment

Disaster prevention/crime prevention equipment

Safety equipment

Other applications that are not considered general-purpose applications

- We may modify products or discontinue production of a product listed in this catalog without prior notification.
- We provide "Delivery Specification" that explain precautions for the specifications and safety of each product listed in this catalog. We strongly recommend that you exchange these delivery specifications with customers that use one of these products.
- If you plan to export a product listed in this catalog, keep in mind that it may be a restricted item according to the "Foreign Exchange and Foreign Trade Control Law". In such cases, it is necessary to acquire export permission in harmony with this law.
- Any reproduction or transferring of the contents of this catalog is prohibited without prior permission from our company.
- We are not responsible for problems that occur related to the intellectual property rights or other rights of our company or a third party when you use a product listed in this catalog. We do not grant license of these rights.
- This catalog only applies to products purchased through our company or one of our company's official agencies. This catalog does not apply to products that are purchased through other third parties.

