

# THIN FILM PRECISION CHIP RESISTOR

## - RN SERIES -

### FEATURES

- Advanced thin film technology
- Very tight tolerance down to  $\pm 0.01\%$
- Extremely low TCR down to  $\pm 2\text{PPM}/^\circ\text{C}$
- Wide resistance range 1ohm
- 3Mega ohm
- Miniature size 0201 available
- Value range, indicating that all values of E-24 and E-96, and values under E-192 can be available upon request



### APPLICATIONS

- Medical Equipment
- Testing / Measurement Equipment
- Printer Equipment
- Automatic Equipment Controller
- Converters
- Communication Device, Cell Phone, GPS, PDA

### DERATING CURVE

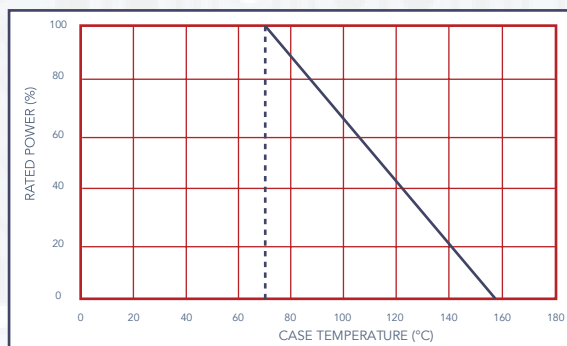

### CONSTRUCTION AND DIMENSIONS

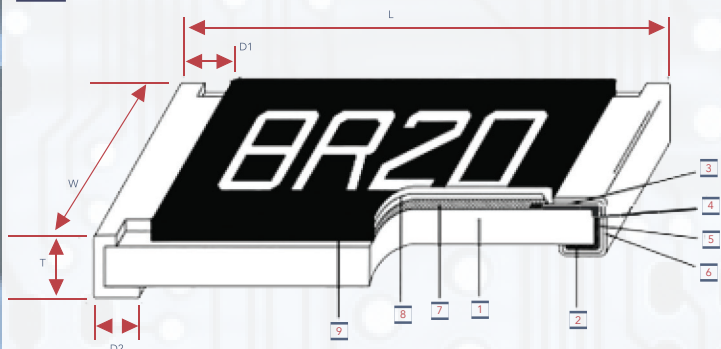

- |                         |  |                              |
|-------------------------|--|------------------------------|
| 1 Alumina Substrate     | 4 Edge Electrode (NiCr)                      | 7 Resistor Layer             |
| 2 Bottom Electrode (Ag) | 5 Barrier Layer (Ni) 3~12 $\mu\text{m}$      | 8 Primary Overcoat (glass)   |
| 3 Top Electrode (Ag-pd) | 6 External Electrode (Sn) 3~15 $\mu\text{m}$ | 9 Secondary Overcoat (Epoxy) |

TYPE	SIZE (INCH)	L (MM)	W (MM)	T (MM)	D1 (MM)	D2 (MM)	WEIGHT (G) (1000S)
RN02	0201	0.58 $\pm$ 0.05	0.29 $\pm$ 0.05	0.23 $\pm$ 0.05	0.12 $\pm$ 0.05	0.15 $\pm$ 0.05	0.14
RN04	0402	1.00 $\pm$ 0.10	0.50 $\pm$ 0.05	0.35 $\pm$ 0.05	0.20 $\pm$ 0.10	0.20 $\pm$ 0.10	0.54
RN06	0603	1.55 $\pm$ 0.10	0.80 $\pm$ 0.10	0.45 $\pm$ 0.15	0.30 $\pm$ 0.20	0.30 $\pm$ 0.20	1.83
RN10	0805	2.00 $\pm$ 0.15	1.25 $\pm$ 0.15	0.50 $\pm$ 0.15	0.35 $\pm$ 0.20	0.40 $\pm$ 0.25	4.71
RN12	1206	3.05 $\pm$ 0.15	1.55 $\pm$ 0.15	0.55 $\pm$ 0.15	0.42 $\pm$ 0.20	0.35 $\pm$ 0.25	9.02
RN14	1210	3.10 $\pm$ 0.15	2.60 $\pm$ 0.15	0.55 $\pm$ 0.10	0.42 $\pm$ 0.20	0.55 $\pm$ 0.25	10
RN20	2010	5.00 $\pm$ 0.10	2.50 $\pm$ 0.15	0.55 $\pm$ 0.10	0.60 $\pm$ 0.30	0.55 $\pm$ 0.25	23.61
RN25	4527	6.30 $\pm$ 0.15	3.10 $\pm$ 0.15	0.55 $\pm$ 0.10	0.60 $\pm$ 0.30	0.55 $\pm$ 0.25	38.06

### PART NUMBERING GUIDE

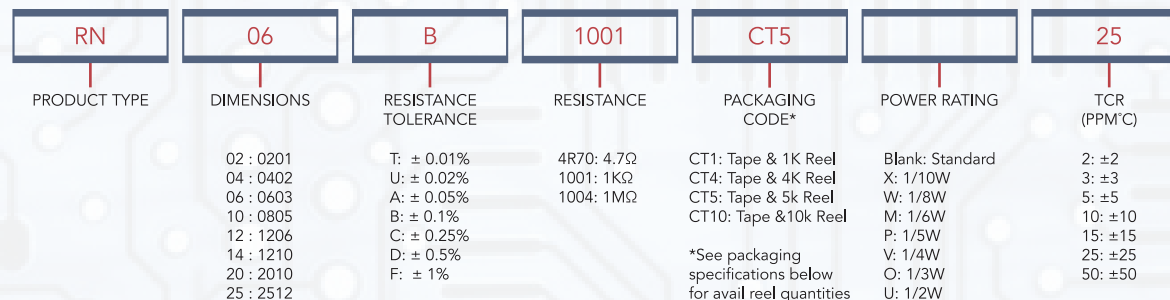

## STANDARD ELECTRICAL SPECIFICATIONS

TYPE	ITEM	POWER RATING AT 70°C	OPERATING TEMP RANGE	MAX OPERATING VOLTAGE	MAX OVERLOAD VOLTAGE	RESISTANCE RANGE					TCR (PPM/°C)
						±0.01% ±0.02% ±0.05%	±0.1%	±0.25%	±0.5%	±1%	
RN02	0201	1/32W	-55 ~ +155°C	15V	30V	-	100Ω-12KΩ	-	39Ω - 12KΩ		±25
						-	100Ω-12KΩ	-	39Ω - 33KΩ		±50
RN04	0402	1/16W		25V	50V	10Ω - 255KΩ					±25   ±50
RN06	0603	1/16W		50V	100V	3.9Ω - 1MΩ		2Ω - 1MΩ			±25   ±50
RN10	0805	1/10W		100V	200V	4.7Ω - 2MΩ		1Ω - 2MΩ			±25   ±50
RN12	1206	1/8W		150V	300V	1Ω-2.49MΩ		1Ω - 2.49MΩ			±25   ±50
						4.7Ω-2.49MΩ					
RN20	2010	1/2W		150V	300V	4.7Ω - 3MΩ		1Ω - 3MΩ			±25   ±50
RN25	2512	3/4W	1Ω - 3MΩ								

Lower Resistance: 1~10Ω

## SPECIAL ELECTRICAL SPECIFICATIONS

TYPE	ITEM	POWER RATING AT 70°C	OPERATING TEMP RANGE	MAX OPERATING VOLTAGE	MAX OVERLOAD VOLTAGE	RESISTANCE RANGE					TCR (PPM/°C)
						±0.01%   ±0.02%	±0.05%	±0.1%	±0.25%	±0.5%	
RN04	0402	1/16W	-55 ~ +155°C	25V	50V	10Ω - 8KΩ			10Ω - 10KΩ	10Ω - 8KΩ	±2 / ±3
						10Ω - 10KΩ					±5
						10Ω - 20KΩ					±10 / ±15
RN06	0603	1/16W		50V	100V	4.7Ω - 40KΩ			±2 / ±3 / ±5		
						4.7Ω - 100KΩ			±10 / ±15		
RN10	0805	1/10W		100V	200V	4.7Ω - 80KΩ			4.7Ω - 100KΩ	4.7Ω - 80KΩ	±2 / ±3 / ±5
						4.7Ω - 200KΩ	4.7Ω - 500KΩ			±10 / ±15	
RN12	1206	1/8W		150V	300V	4.7Ω - 120KΩ			4.7Ω - 150KΩ	4.7Ω - 120KΩ	±2 / ±3 / ±5
			4.7Ω - 300KΩ			4.7Ω - 1MΩ			±10 / ±15		
RN14	1210	1/4W	150V	300V	4.7Ω - 150KΩ			±2 / ±3 / ±5			
					4.7Ω - 400KΩ			±10 / ±15			
RN20	2010	1/2W	150V	300V	4.7Ω - 360KΩ			±2 / ±3 / ±5			
					4.7Ω - 500KΩ	4.7Ω - 1MΩ			±10 / ±15		
RN25	2512	3/4W	150V	300V	4.7Ω - 600KΩ			±2 / ±3 / ±5			
					4.7Ω - 1.5MΩ			±10 / ±15			



## HIGH POWER AND ULTRA HIGH POWER RATING ELECTRICAL SPECIFICATIONS

TYPE	ITEM	POWER RATING AT 70°C	OPERATING TEMP RANGE	MAX OPERATING VOLTAGE	MAX OVERLOAD VOLTAGE	RESISTANCE RANGE						TCR (PPM/°C)
						±0.01%   ±0.02%	±0.05%	±0.1%	±0.25%	±0.5%	±1%	
RN02	0201	1/20W	-55 ~ + 155°C	25V	50V	-		22Ω - 75KΩ				±25 / ±50
RN04	0402	1/10W		50V	100V	49.9Ω - 4.99KΩ			-			±1 / ±2 / ±3
						49.9Ω - 20KΩ						±5
						49.9Ω - 12KΩ			49.9Ω - 100KΩ			±10 / ±15
						-	49.9Ω - 12KΩ	4.7Ω - 255KΩ			±25 / ±50	
RN06	0603	1/10W		75V	150V	24.9Ω - 16KΩ						±2 / ±3 / ±5
						24.9Ω - 100KΩ	4.7Ω - 332KΩ	4.7Ω - 1MΩ				±10 / ±15
						4.7Ω - 1MΩ						±25 / ±50
RN10	0805	1/8W		150V	300V	24.9Ω - 30KΩ						±2 / ±3 / ±5
						24.9Ω - 200KΩ	4.7Ω - 511KΩ	4.7Ω - 332KΩ		±10		
		4.7Ω - 1MΩ						±15				
		-				-	4.7Ω - 1MΩ	1Ω - 1MΩ		±25 / ±50		
RN12	1206	1/4W		200V	400V	24.9Ω - 49.9KΩ						±2 / ±3 / ±5
						24.9Ω - 499KΩ	4.7Ω - 1MΩ				±5 / ±10 / ±15 / ±25 / ±50	
		-				10Ω - 1MΩ				±25 / ±50		
RN14	1210	1/3W	200V	400V	24.9Ω - 49.9KΩ						±2 / ±3 / ±5	
		1/3W			24.9Ω - 499KΩ	4.7Ω - 1MΩ				±10 / ±15 / ±25 / ±50		
RN20	2010	3/4W	200V	400V	24.9Ω - 49.9KΩ						±2 / ±3 / ±5	
RN25	2512	1W	200V	400V	24.9Ω - 499KΩ	10Ω - 1MΩ				±10 / ±15 / ±25 / ±50		
					10Ω - 1.5MΩ						±25 / ±50	

## ENVIRONMENTAL CHARACTERISTICS

ITEM	REQUIREMENT		TEST METHOD
	TOL. ≤0.05%	TOL. > 0.05%	
Temperature Coefficient of Resistance (T.C.R.)	As Spec.		+25/-55/+25/+125/+25°C
Short Time Overload	ΔR ±0.05%	Δr ±0.2%	RCWV*2.5 or Max. overload voltage for 5 seconds
	ΔR ±0.2% for high power rating		
Insulation Resistance	>1000MΩ		Apply 100V <sub>DC</sub> for 5 seconds
Endurance	ΔR±0.05%	ΔR±0.2%	70±2°C, Max. working voltage for 1000 hrs with 1.5 hrs "ON" and 0.5 hrs "OFF"
	>7kΩ ΔR±0.5%		
	ΔR±0.5% for high power rating		
Damp Heat with Load	ΔR±0.05%	ΔR±0.3%	40±2°C, 90~95% R.H. Max working voltage for 1000 hrs with 1.5 hrs "ON" and 0.5 hrs "OFF"
	ΔR±0.5% for high power rating		
Bending Strength	ΔR±0.05%	ΔR±0.2%	Bending amplitude 3 mm for 10 seconds
Solderability	95% min. coverage		245±5°C for 3 seconds
Resistance to Soldering Heat	ΔR±0.05%	ΔR±0.2%	260±5°C for 10 seconds
Dielectric Withstand Voltage	By Type		Max. overload voltage for 1 minute
Thermal Shock	ΔR±0.05%	ΔR±0.25%	-5°C~150°C, 100 cycles
Low Temperature Operation	ΔR±0.05%	ΔR±0.2%	1 hour, -65°C, followed by 45 minutes of RCWV
	ΔR±0.5% for high power rating		

Reference standards: mil-std-202, jis-c 5201-1 | Storage temperature: 25±3°C; humidity <80%rh

# PACKAGING

## - Packaging Quantity & Reel Specifications

TYPE	ØA	ØB	ØC	W	T	UNIT= MM	
						PAPER TAPE	EMBOSSED PLASTIC TAPE
RN02	178.0 ± 1.0	60.0 + 1.0	13.5 ± 0.7	9.5 ± 1.0	11.5 ± 1.0	10k / 1k	
RN04	178.0 ± 1.0	60.0 + 1.0	13.5 ± 0.7	9.5 ± 1.0	11.5 ± 1.0	10k / 1k	
RN06	178.0 ± 1.0	60.0 + 1.0	13.5 ± 0.7	9.5 ± 1.0	11.5 ± 1.0	5k / 1k	
RN10	178.0 ± 1.0	60.0 + 1.0	13.5 ± 0.7	9.5 ± 1.0	11.5 ± 1.0	5k / 1k	
RN12	178.0 ± 1.0	60.0 + 1.0	13.5 ± 0.7	9.5 ± 1.0	11.5 ± 1.0	5k / 1k	
RN14	178.0 ± 1.0	60.0 + 1.0	13.5 ± 0.7	9.5 ± 1.0	11.5 ± 1.0	5k / 1k	
RN20	178.0 ± 1.0	60.0 + 1.0	13.5 ± 0.7	9.5 ± 1.0	11.5 ± 1.0		4k / 1k
RN25	178.0 ± 1.0	60.0 + 1.0	13.5 ± 0.7	9.5 ± 1.0	11.5 ± 1.0		4k / 1k

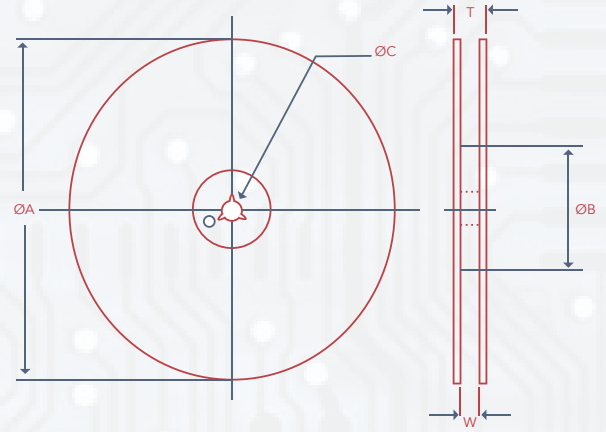

## - Paper Tape Specifications

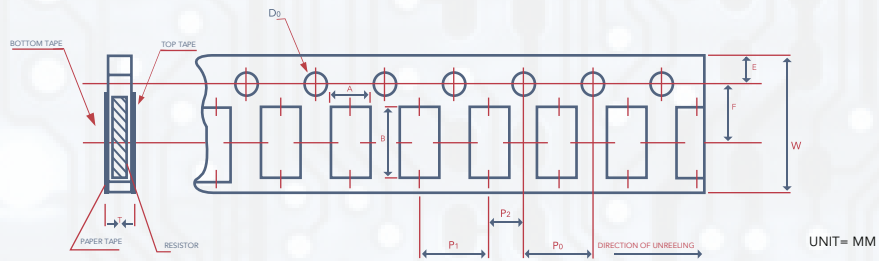

TYPE	A	B	W	E	F	P0	P1	P2	ØD0	T
RN02	0.40 ± 0.05	0.70 ± 0.05	8.00 ± 0.10	1.75 ± 0.05	3.5 ± 0.05	4.00±0.10	2.00±0.05	2.00±0.05	1.55±0.03	0.42±0.02
RN04	0.70 ± 0.05	1.16 ± 0.05	8.00 ± 0.10	1.75 ± 0.05	3.5 ± 0.05	4.00±0.10	2.00±0.05	2.00±0.05	1.55±0.05	0.40±0.03
RN06	1.10 ± 0.05	1.90 ± 0.05	8.00 ± 0.10	1.75 ± 0.05	3.5 ± 0.05	4.00±0.10	2.00±0.10	2.00±0.10	1.55±0.05	0.60±0.03
RN10	1.60 ± 0.05	2.37 ± 0.05	8.00 ± 0.10	1.75 ± 0.05	3.5 ± 0.05	4.00±0.10	2.00±0.10	2.00±0.10	1.55±0.05	0.75±0.05
RN12	2.00 ± 0.05	3.55 ± 0.05	8.00 ± 0.10	1.75 ± 0.05	3.5 ± 0.05	4.00±0.10	2.00±0.10	2.00±0.10	1.55±0.05	0.75±0.05
RN14	2.75 ± 0.05	3.40 ± 0.05	8.00 ± 0.10	1.75 ± 0.05	3.5 ± 0.05	4.00±0.05	2.00±0.10	2.00±0.10	1.50±0.10	0.75±0.05

## - Embossed Plastic Tape Specifications

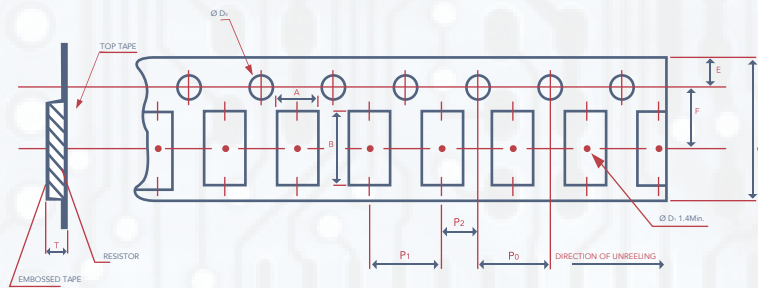

TYPE	A	B	W	E	F	P0	P1	P2	ØD0	T
RN20	2.85±0.10	5.45±0.10	12.00±0.10	1.75 ± 0.10	5.5±0.05	4.00±0.05	4.00±0.10	2.00±0.05	1.50±0.10	1.00±0.20
RN25	3.40±0.10	6.65±0.10	12.00±0.10	1.75 ± 0.10	5.5±0.05	4.00±0.05	4.00±0.10	2.00±0.10	1.50±0.10	1.00±0.20



## RECOMMENDED LAND PATTERN

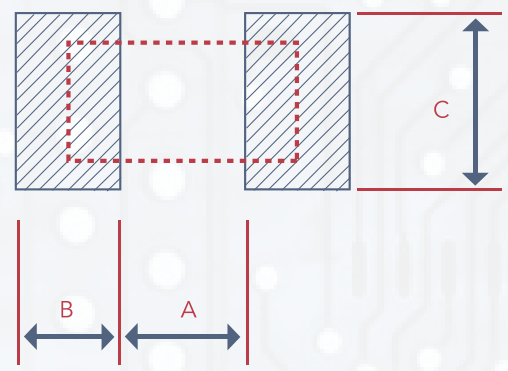

TYPE	A (MM)	B (MM)	C (MM)
RN02	.25	.30	0.40 ± 0.2
RN04	0.50	0.50	0.60 ± 0.2
RN05	0.50	0.50	0.60 ± 0.2
RN06	0.80	1.00	0.90 ± 0.2
RN10	1.00	1.00	1.35 ± 0.2
RN12	2.00	1.15	1.70 ± 0.2
RN14	2.00	1.15	2.50 ± 0.2
RN20	3.60	1.40	2.50 ± 0.2
RN25	4.90	1.60	3.10 ± 0.2

## SOLDERING CONDITION

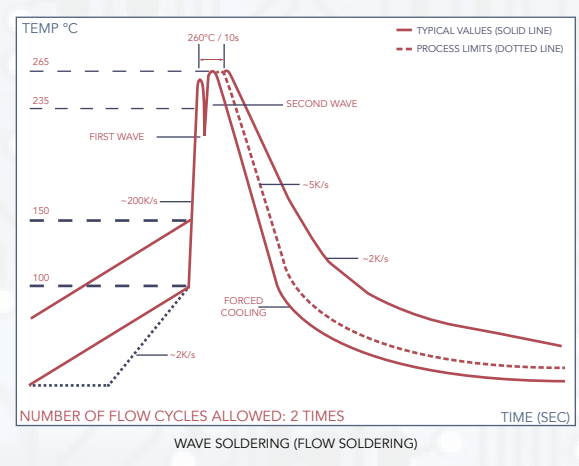
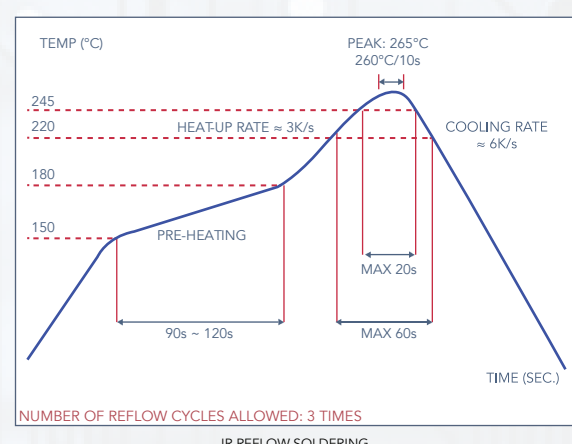

- Time of IR Reflow soldering at maximum temperature point 260°C : 10s
- Time of wave soldering at maximum temperature point 260°C : 10s
- Time of soldering iron at maximum temperature point 410°C : 5s

# MARKING

## - 0603 - 3 DIGIT MARKING



3 digit marking for Example

14C = 13K7Ω  
13C = 13K3Ω

68B = 4K99Ω  
68X = 49.9Ω

## - MARKING TABLE

CODE	E96	CODE	E96	CODE	E96	CODE	E96		
01	100	25	178	49	316	73	562		
02	102	26	182	50	324	74	576		
03	105	27	187	51	332	75	590		
04	107	28	191	52	340	76	604		
05	110	29	196	53	348	77	619		
506	113	30	200	54	357	78	634		
07	115	31	205	55	36	79	649		
08	118	32	210	56	374	80	665		
09	121	33	215	57	383	81	681		
10	124	34	221	58	392	82	698		
11	127	35	226	59	402	83	715		
12	130	36	232	60	412	84	732		
13	133	37	237	61	422	85	750		
14	137	38	243	62	432	86	768		
15	140	39	249	63	442	87	787		
16	143	40	255	64	453	88	806		
17	147	41	261	65	464	89	825		
18	150	42	267	66	475	90	845		
19	154	43	274	67	487	91	866		
20	158	44	280	68	499	92	887		
21	162	45	287	69	511	93	909		
22	165	46	294	70	523	94	931		
23	169	47	301	71	536	95	952		
24	174	48	309	72	549	96	976		
CODE	A	B	C	D	E	F	G	X	Y
MULTIPLIER	10 <sup>0</sup>	10 <sup>1</sup>	10 <sup>2</sup>	10 <sup>3</sup>	10 <sup>4</sup>	10 <sup>5</sup>	10 <sup>6</sup>	10 <sup>-1</sup>	10 <sup>-2</sup>

### 0603 - 3 digit marking in E24

Example: 101 = 100Ω 102 = 1KΩ

E24 CODE	10	11	12	13	15	16	18	20	22	24	27	30	33	36	39	43	47	51	56	62	68	75	82	91
----------	----	----	----	----	----	----	----	----	----	----	----	----	----	----	----	----	----	----	----	----	----	----	----	----

### 0805~2512 4 digit marking

EX:

RESISTANCE	100Ω	2.2KΩ	10KΩ	4.9KΩ	100KΩ
MARKING	1000	2201	1002	4992	1003

E-192 values are also available upon request but will have no marking on the part. Please ask sales rep for a quote and lead-time for any e-192 values.

