

AUTOMOTIVE GRADE

- CAR SERIES -

FEATURES

- Special construction to prevent sulfuration in a sulfur containing environment
- AEC-Q200 Compliance

APPLICATIONS

- Automotive
- High-end Computer
- Industrial Equipment
- Automatic Equipment Controller
- Medical Equipment
- High-end Multimedia Electronics
- Outdoor Electronic Applications



CONSTRUCTION & DIMENSIONS

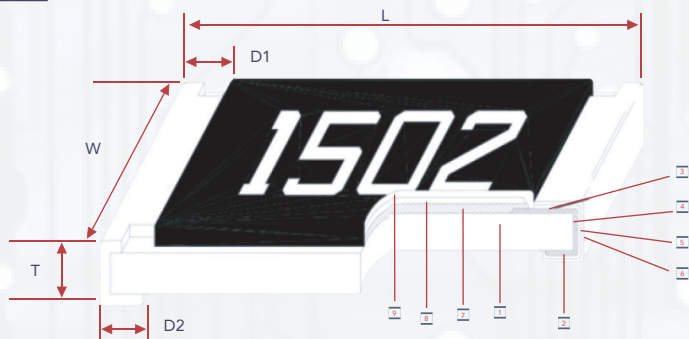

- | | | |
|-------------------------|---------------------------|------------------------------|
| 1 Alumina Substrate | 4 Edge Electrode (NiCr) | 7 Resistor Layer |
| 2 Bottom Electrode (Ag) | 5 Barrier Layer (Ni) | 8 Primary Overcoat (glass) |
| 3 Top Electrode (Ag-Pd) | 6 External Electrode (Sn) | 9 Secondary Overcoat (Epoxy) |

DERATING CURVE

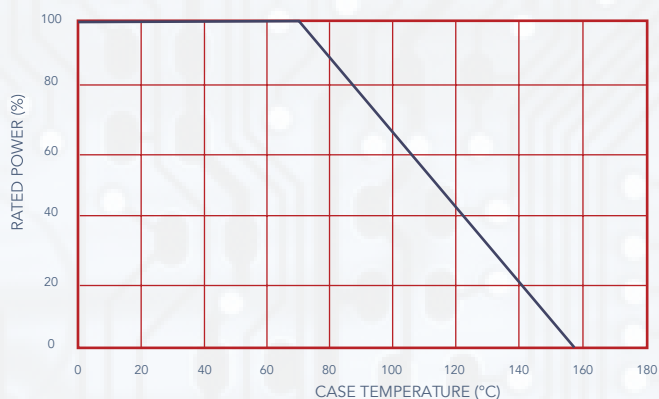

SOLDERING CONDITION

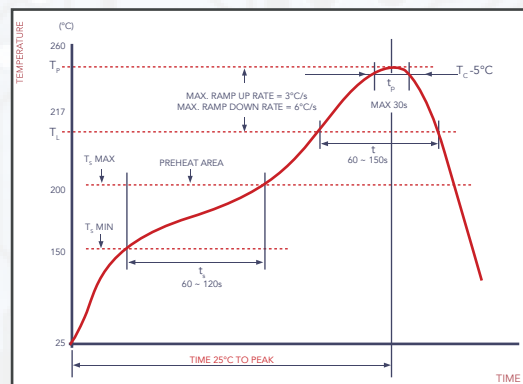

TYPE	SIZE INCH	L	W	T	D1	D2
CAR02	0201	0.60 ± 0.03	0.30 ± 0.03	0.23 ± 0.03	0.12 ± 0.05	0.15 ± 0.05
CAR04	0402	1.00 ± 0.05	0.50 ± 0.05	0.35 ± 0.05	0.25 ± 0.10	0.20 ± 0.10
CAR06	0603	1.60 ± 0.10	0.80 ± 0.10	0.45 ± 0.10	0.30 ± 0.20	0.30 ± 0.20
CAR10	0805	2.00 ± 0.15	1.25 ± 0.15	0.55 ± 0.10	0.40 ± 0.20	0.40 ± 0.20
CAR12	1206	3.10 ± 0.15	1.55 ± 0.15		0.50 ± 0.25	0.50 ± 0.20
CAR14	1210	3.10 ± 0.10	2.60 ± 0.20			
CAR20	2010	5.00 ± 0.10	2.50 ± 0.20			
CAR25	2512	6.35 ± 0.10	3.10 ± 0.20		0.60 ± 0.25	

PART NUMBERING

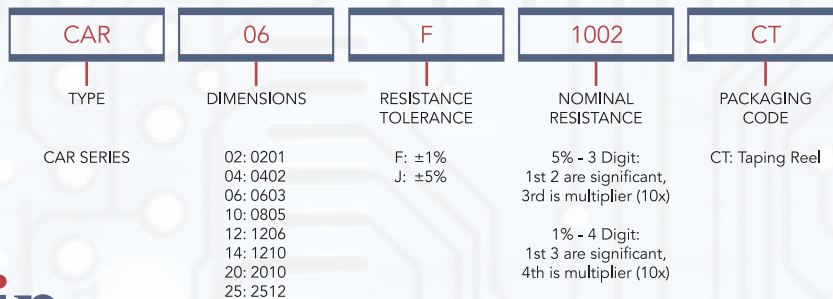

STANDARD ELECTRICAL SPECIFICATIONS

TYPE	POWER RATING AT 70°C	OPERATING TEMP. RANGE	MAX OPERATING VOLTAGE	MAX OVERLOAD VOLTAGE	RESISTANCE RANGE		T.C.R. (PPM / °C)
					±1%	±5%	
CAR02 (0201)	1/20 W	-55 ~ +155°C	25V	50V	1Ω ≤ R ≤ 10Ω	>10Ω	-100 ~ +350 ±200
	Jumper: 0.5A						
CAR04 (0402)	1/16 W		50V	100V	1Ω ~ 9.76Ω 10Ω - 1MΩ 1.02MΩ - 10MΩ		±200 ±100
	Jumper: 1A				0Ω (<50MΩ)	-	
CAR06 (0603)	1/10 W		75V	150V	1Ω ~ 9.76Ω 10Ω - 1MΩ 1.02MΩ - 10MΩ		±200 ±100
	Jumper: 1A				0Ω (<50MΩ)	-	
CAR10 (0805)	1/8 W		150V	300V	1Ω ~ 9.76Ω 10Ω - 1MΩ 1.02MΩ - 10MΩ		±200 ±100
	Jumper: 2A				0Ω (<50MΩ)	-	
CAR12 (1206)	1/4 W		200V	400V	1Ω ~ 9.76Ω 10Ω - 1MΩ 1.02MΩ - 10MΩ		±200 ±100
	Jumper: 2A				0Ω (<50MΩ)	-	
CAR14 (1210)	1/2 W	200V	500V	1Ω ~ 9.76Ω 10Ω - 1MΩ 1.02MΩ - 10MΩ		±200 ±100	
	Jumper: 2A			0Ω (<50MΩ)	-		
CAR20 (2020)	3/4 W	200V	500V	1Ω ~ 9.76Ω 10Ω - 1MΩ 1.02MΩ - 10MΩ		±200 ±100	
	Jumper: 2A			0Ω (<50MΩ)	-		
CAR25 (2512)	1W	250V	500V	1Ω ~ 9.76Ω 10Ω - 1MΩ 1.02MΩ - 10MΩ		±200 ±100	
	Jumper 2A			0Ω (<50MΩ)	-		

Operating Voltage - $\sqrt{P \cdot R}$; or Max. Operating Voltage listed above, whichever is lower.
 Cal-Chip is capable of manufacturing the optional spec based on customer's requirement.

Overload Voltage - $2.5 \cdot \sqrt{P \cdot R}$ or Max. Operating Voltage listed above, whichever is lower.

MARKING

- MULTIPLIER CODE:

VALUE	CODE	VALUE	CODE	VALUE	CODE	VALUE	CODE	VALUE	CODE		
100	01	162	21	261	41	422	61	681	81		
102	02	165	22	267	42	432	62	698	82		
105	03	169	23	274	43	442	63	715	83		
107	04	174	24	280	44	453	64	732	84		
110	05	178	25	287	45	464	65	750	85		
113	06	182	26	294	46	475	66	768	86		
115	07	187	27	301	47	487	67	787	87		
118	08	191	28	309	48	499	68	806	88		
121	09	196	29	316	49	511	69	825	89		
124	10	200	30	324	50	523	70	845	90		
127	11	205	31	332	51	536	71	866	91		
130	12	210	32	340	52	549	72	887	92		
133	13	215	33	348	53	562	73	909	93		
137	14	221	34	357	54	576	74	931	94		
140	15	226	35	365	55	590	75	953	95		
143	16	232	36	374	56	604	76	976	96		
147	17	237	37	383	57	619	77				
150	18	243	38	392	58	634	78				
154	19	249	39	402	59	649	79				
158	20	255	40	412	60	665	80				
CODE	A	B	C	D	E	F	G	H	X	Y	Z
MULTIPLIER	10 ⁰	10 ¹	10 ²	10 ³	10 ⁴	10 ⁵	10 ⁶	10 ⁷	10 ⁻¹	10 ⁻²	10 ⁻³



MARKING

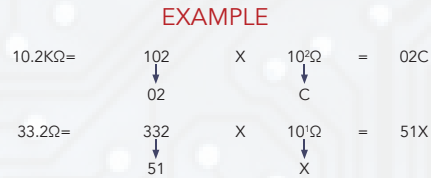
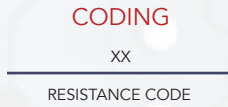

- Marking for CAR06 E-24, E-96 series, the resistance value that no have multiplier code indicate marking follow this:
The first two digits are significant figures of resistance and the third one denoted number of zeros and under line the marking letters.

- Example



- RESISTORS

Marking for E-96 series in CAR10, CAR12, CAR14, CAR20, CAR25 size : 4 Digits

*The first 3 digits are singnificant figures of resistance and the 4th digit denoted number of zeros.

*For ohmic values below 100 Ω, letter "R" is for decimal point.

Example



Example



*For ohmic values below 10 Ω

Example



Marking for E-24 series in CAR10, CAR12, CAR14, CAR20, CAR25 size : 3 Digits

*The first 2 digits are singnificant figures of resistance and the 3rd digit denoted number of zeros.

- 0Ω Marking:

Normally, the marking of 0Ω CAR10, CAR12, CAR14, CAR20, CAR25 resistors as following

Example



Example



- LABLES

Label shall be marked with the following item :

- A: Cal-Chip Part Number
- B: Customer P/N Where Applicable
- C: Quantity
- D: Date Code
- E: Lot No.

PERFORMANCE SPECIFICATION

CHARACTERISTICS	LIMITS	TEST METHODS
Operational Life	$\pm 1\%$: $\pm(1.0\%+0.1\Omega)$ Max. $\pm 5\%$: $\pm(3.0\%+0.1\Omega)$ Max.	1,000 hours at $125\pm 3^\circ\text{C}$, applied de-rated (36%) power of continuous working voltage, 1.5 hours on, 0.5 hour off, still air required.
	<100m Ω	Apply to rate current for 0 Ω
Temperature Coefficient	CAR02: $1\Omega \leq R \leq 10\Omega$: $-100 \sim +350$ ppm/ $^\circ\text{C}$ >10 Ω : ± 200 ppm/ $^\circ\text{C}$ CAR04 - CAS25: $1\Omega \leq R \leq 10\Omega$: ± 200 ppm/ $^\circ\text{C}$ >10 Ω : ± 100 ppm/ $^\circ\text{C}$	Parametrically test per lot and sample size requirements, summary to show Min, Max, Mean and Standard deviation at room as well as Min and Max operating temperatures
Short-Time Overload	$\pm 1\%$: $\pm(1.0\%+0.05\Omega)$ Max $\pm 5\%$: $\pm(2.0\%+0.05\Omega)$ Max	4.13 Permanent resistance change after the application of potential of 2.5 times RCWV or Max. Overload Voltage whichever less for 5 seconds (JIS-C-5201& JIS-C-5202)
	<50m Ω	Apply max Overload Current for 0 Ω
External Visual	No Mechanical Damage	Electrical test not required. Inspect device construction, marking and workmanship (MIL-STD-883 Method 2009)
Physical Dimension	Reference 5. Dimension Standards	Certify physical dimensions to the applicable device detail specification. Note: User(s) and supplies spec. Electrical test not required. (JESD22 MH Method JB-100)
Resistance to Solvent	Marking Unsmearred	Note: Add Aqueous wash chemical - OKEM Clean or equivalent. Do not use banned solvents. (MIL-STD-202 Method 215)
Terminal Strength	Not Broken	Force 1.8kg for 60 seconds.. (JIS-C-6429)
High Temperature Exposure (Storage)	$\pm(1.0\%+0.05\Omega)$ Max.	1000hrs. @T= 155°C . Unpowered. Measurement at 24 ± 2 hours after test conclusion (MIL-STD-202 Method 108)
	<50m Ω	Apply to rate current for 0 Ω
Temperature Cycling	$\pm(1.0\%+0.05\Omega)$ Max.	1000 Cycles (-55°C to $+155^\circ\text{C}$). Measurement at 24 ± 2 hours after test conclusion. (JESD22 Method JA-104)
	<50m Ω	Apply to rate current for 0 Ω
Biased Humidity	1%: $\pm(1.0\%+0.05\Omega)$ Max. 5%: $\pm(3.0\%+0.05\Omega)$ Max	10% rated power, $85^\circ\text{C}/85\%RH$, 1000Hr, Measurement at 24 hours after test conclusion. (MIL-STD-202 Method 103)
	<100m Ω	Apply to rate current for 0 Ω
Mechanical Shock	$\pm(1.0\%+0.05\Omega)$ Max.	Wave Form: Tolerance for half sine shock pulse. Peak value is 100g's. Normal duration (D) is 6ms, velocity 12.3ft/s 100Hz. (MIL-STD-202 Method 213)
Vibration	$\pm(1.0\%+0.05\Omega)$ Max.	5g's for 20 min., 12cycle each of 3 orientations. Note: Use 8" * 5" PCB. 031" thick 7 secure points on one long side and 2 secure points at corners of opposite sides. Parts mounted within 2' from any secure point. Test from 10-2000Hz. (MIL-STD-202 Method 204)
ESD	$\pm(1.0\%+0.05\Omega)$ Max.	With the electrometer in direct contact with the discharge tip, verify the voltage setting at levels of $\pm 500\text{V}$, $\pm 1\text{KV}$, $\pm 2\text{KV}$, $\pm 4\text{KV}$, $\pm 8\text{KV}$, The electrometer reading shall be within $\pm 10\%$ for voltages from 500V to $\leq 800\text{V}$.
Solderability	95% Coverage Min	For both leaded & SMD. Electrical test not required. Magnification 50X. Conditions: a) Method B 4hrs at 155°C dry heat, the dip in bath with 245°C , 5s. b) Method B: at 215°C , 5s. c) Method D: at 260°C , 60s. (J-STD-002)
Flammability	No ignition of the tissue paper or scorching or the pinewood board	V-0 or V-1 are acceptable. Electrical test not required (UL-94)
Board Flex	$\pm(1.0\%+0.05\Omega)$ Max.	Bending 3mm (CAR02-CAS10) / 2mm (CAR12-CAR25) for 60 ± 5 sec. (JIS-C-6429)
	<50m Ω	Apply to rate current for 0 Ω
Flame Retardance	No Flame	Temperature at 500°C , Voltage powr subjected to 32VDC current clamped up to 500 VDC and decreased in 1.0VDC/hour. (AEC-Q200-001)
Resistance to Soldering Heat	$\pm(1.0\%+0.05\Omega)$ Max.	Conidition B no per-heat of samples. Note: Single Wave Solder-Procedure 2 for SMD and Procedure 1 for Leaded with solder within 1.5mm of device body. (MIL-STD-202 Mehtod 210)
	<50m Ω	Apply to rate current for 0 Ω



PACKAGING

- Reel Specifications & Packaging Quantity

TYPE	PACKAGING QUANTITY	TYPE WIDTH	REEL DIAMETER	ØA	ØB	ØC	W	T							
CAR02	Paper	15K	7 inch	178.5 ± 1.5	60 ^{+1/0}	13.0 ± 0.5	10 ± 1	12.5 ± 0.5							
CAR04		10K													
CAR06		5K							8mm	7 inch	178.5 ± 1.5	60 ^{+1/0}	13.0 ± 0.5	9.0 ± 0.5	12.5 ± 0.5
CAR10															
CAR12															
CAR14															
CAR20	Embossed	4K	12mm	7 inch	178.5 ± 1.5	60 ^{+1/0}	13.0 ± 0.5	13.0 ± 0.5	15.5 ± 0.5						
CAR25															

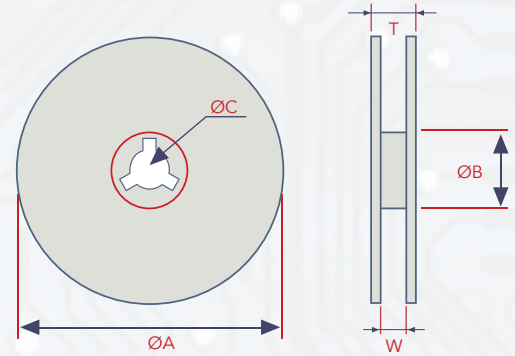

- Paper Tape Specifications

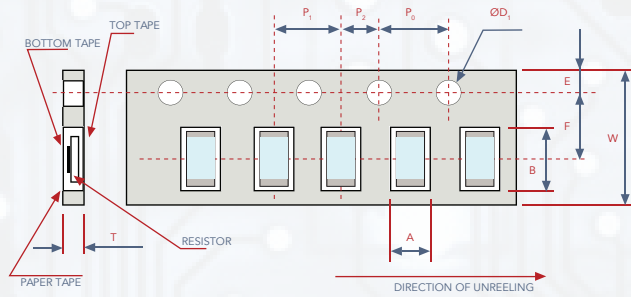

TYPE	A	B	W	E	F	P ₀	P ₁	P ₂	ØD ₀	T
CAR02	0.40±0.05	0.70±0.05	8.0±0.20	1.75±0.10	3.50±0.05	4.00±0.10	2.00±0.05	2.00±0.05	1.50+0.1,-0	0.42±0.10
CAR04	0.65±0.10	1.15±0.10								0.45±0.10
CAR06	1.10±0.10	1.90±0.10								0.67±0.10
CAR10	1.60±0.10	2.40±0.20					4.00±0.05			0.81±0.10
CAR12	1.90±0.10	3.50±0.20								
CAR14	2.90±0.10	3.50±0.20								

- Embossed Tape Specifications

TYPE	A	B	W	E	F	P ₀	P ₁	P ₂	ØD ₀	T
CAR20	2.9±0.20	5.6±0.20	12.0±0.30	1.75±0.10	5.5±0.05	4.00±0.10	4.00±0.10	2.00±0.05	1.50+0.1,-0	1.2 ^{±0}
CAR25	3.5±0.20	6.7±0.20								

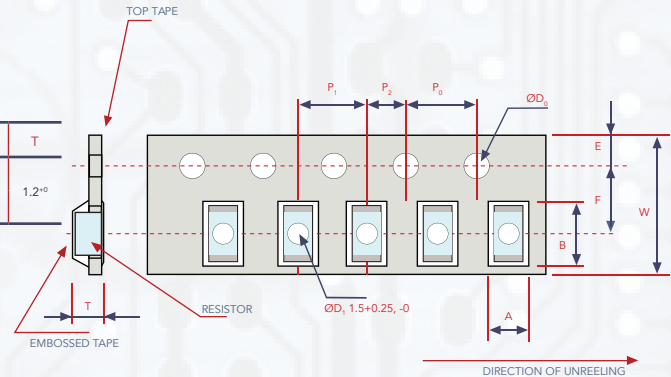

RECOMMENDED LAND PATTERN

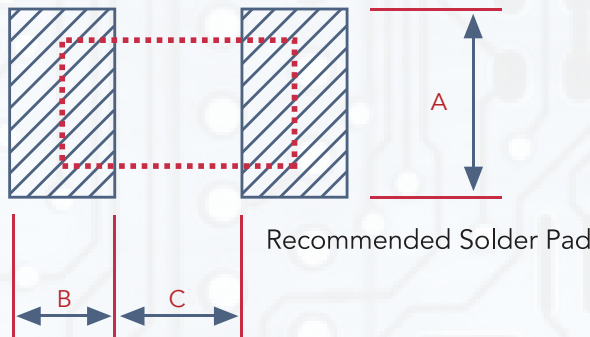

TYPE	A	B	C
CAR02	0.4 ± 0.05	0.35 ± 0.05	0.3 ± 0.05
CAR04	0.5 ± 0.05	0.45 ± 0.05	0.5 ± 0.05
CAR06	0.8 ± 0.05	0.65 ± 0.05	0.8 ± 0.05
CAR10	1.3 ± 0.1	1.0 ± 0.1	1.0 ± 0.1
CAR12	1.6 ± 0.1	1.1 ± 0.1	2.0 ± 0.1
CAR14	2.6 ± 0.1	1.1 ± 0.1	2.0 ± 0.1
CAR20	2.6 ± 0.1	1.3 ± 0.1	3.6 ± 0.1
CAR25	3.3 ± 0.1	1.6 ± 0.1	4.9 ± 0.1