

MULTILAYER CHIP BEADS

- FB SERIES -

FEATURES

- Effective EMI protection
- Low DC resistance
- High soldering heat resistance
- Multiple size availability

APPLICATIONS

- Computers and Peripheral Equipment
- VCRS, Television, Pagers
- Cellular Phones
- Digital Communication Equipment
- Various Electronics Equipments
- Circuit Where a Stable Ground is Unavailable

EXTERNAL DIMENSIONS & CONSTRUCTION

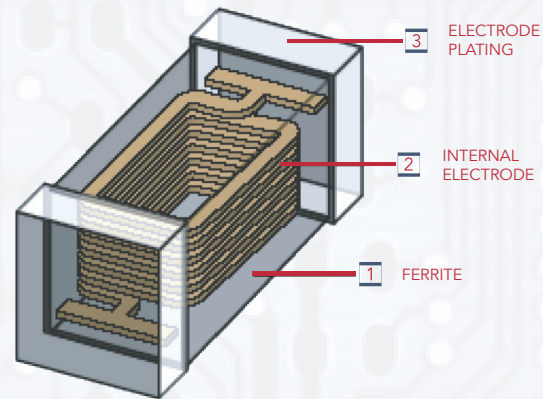
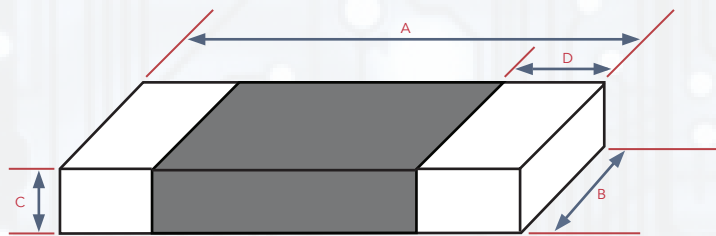

TYPE	SIZE (INCH)	A (MM)	B (MM)	C (MM)	D (MM)	WEIGHT (G) (1000PCS)
FB060303	0201	0.6 ± 0.3	0.30 ± 0.03	0.30 ± 0.03	0.1 ~ 0.2	1.1
FB100505	0402	1.0 ± 0.10	0.50 ± 0.10	0.5 ± 0.10	0.1 ~ 0.35	2.6
FB160808	0603	1.6 ± 0.20	0.80 ± 0.15	0.80 ± 0.15	0.1 ~ 0.6	6.2
FB201209	0805	2.0 ± 0.20	1.25 ± 0.20	0.9 ± 0.20	0.2 ~ 0.8	10
FB321611	1206	3.2 ± 0.20	1.60 ± 0.20	1.1 ± 0.20	0.2 ~ 1.0	30
FB321616	1206	3.2 ± 0.20	1.50 ± 0.20	1.6 ± 0.20	0.5 ~ 0.3	35
FB322513	1210	3.2 ± 0.20	2.50 ± 0.20	1.3 ± 0.20	0.2 ~ 1.0	54
FB451616	1806	4.5 ± 0.25	1.60 ± 0.20	1.6 ± 0.20	0.2 ~ 1.0	60
FB453215	1812	4.5 ± 0.25	3.20 ± 0.20	1.5 ± 0.20	0.2 ~ 1.0	62

PART NUMBERING

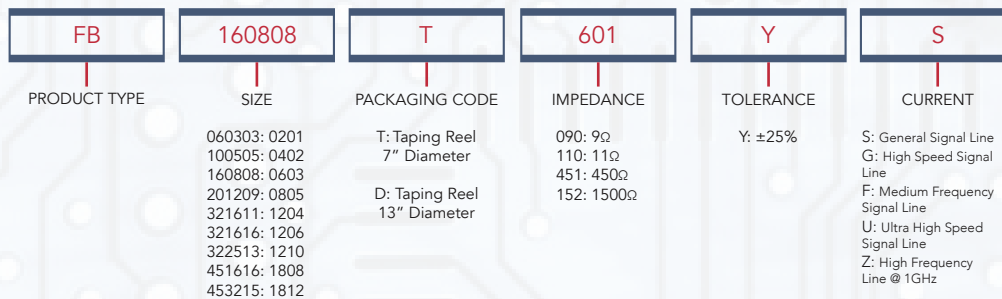



STANDARD ELECTRICAL SPECIFICATIONS (FOR GENERAL SIGNAL LINE)

FB060303 (0201)

PART NUMBER	IMPEDANCE (Ω)	TOLERANCE	TEST FREQUENCY (MHz)	DC RESISTANCE Ω (MAX)	RATED CURRENT mA (MAX) at 85°C
FB060303T-100Y-S	10	±25%	100	0.10	500
FB060303T-110Y-S	11	±25%	100	0.10	500
FB060303T-220Y-S	22	±25%	100	0.065	500
FB060303T-250Y-S	25	±25%	100	0.30	300
FB060303T-300Y-S	30	±25%	100	0.30	300
FB060303T-330Y-S	33	±25%	100	0.30	300
FB060303T-400Y-S	40	±25%	100	0.30	300
FB060303T-500Y-S	50	±25%	100	0.30	300
FB060303T-600Y-S	60	±25%	100	0.35	300
FB060303T-700Y-S	70	±25%	100	0.35	300
FB060303T-800Y-S	80	±25%	100	0.35	300
FB060303T-101Y-S	100	±25%	100	0.40	200
FB060303T-121Y-S	120	±25%	100	0.45	200
FB060303T-151Y-S	150	±25%	100	0.50	200
FB060303T-221Y-S	220	±25%	100	0.75	200
FB060303T-241Y-S	240	±25%	100	0.80	200
FB060303T-301Y-S	300	±25%	100	0.90	150
FB060303T-331Y-S	330	±25%	100	0.90	150
FB060303T-471Y-S	470	±25%	100	1.50	100
FB060303T-601Y-S	600	±25%	100	1.20	100
FB060303T-102Y-S	1000	±25%	100	1.15	200

FB100505 (0402)

PART NUMBER	IMPEDANCE (Ω)	TOLERANCE	TEST FREQUENCY (MHz)	DC RESISTANCE Ω (MAX)	RATED CURRENT mA (MAX) at 85°C
FB100505T-100Y-S	10	±25%	100	0.05	500
FB100505T-200Y-S	20	±25%	100	0.10	300
FB100505T-220Y-S	22	±25%	100	0.35	300
FB100505T-300Y-S	30	±25%	100	0.20	300
FB100505T-300Y-S-1	30	±25%	100	0.20	500
FB100505T-330Y-S 33	33	±25%	100	0.40	300
FB100505T-400Y-S	40	±25%	100	0.20	300
FB100505T-470Y-S	47	±25%	100	0.40	300
FB100505T-560Y-S	56	±25%	100	0.30	400
FB100505T-600Y-S	60	±25%	100	0.40	200
FB100505T-600Y-S-1	60	±25%	100	0.40	300
FB100505T-680Y-S	68	±25%	100	0.15	500
FB100505T-700Y-S	70	±25%	100	0.40	200
FB100505T-700Y-S-1	70	±25%	100	0.25	500
FB100505T-750Y-S	75	±25%	100	0.40	300
FB100505T-800Y-S	80	±25%	100	0.40	200
FB100505T-101Y-S	100	±25%	100	0.45	200
FB100505T-121Y-S	120	±25%	100	0.50	200
FB100505T-121Y-S-1	120	±25%	100	0.20	500



FB100505 (0402) (CONT.)

PART NUMBER	IMPEDANCE (Ω)	TOLERANCE	TEST FREQUENCY (MHz)	DC RESISTANCE Ω (MAX)	RATED CURRENT mA (MAX) at 85°C
FB100505T-121Y-S-2	120	±25%	100	0.30	800
FB100505T-151Y-S	150	±25%	100	0.60	200
FB100505T-181Y-S	180	±25%	100	0.65	100
FB100505T-221Y-S	220	±25%	100	0.70	100
FB100505T-221Y-S-1	220	±25%	100	0.35	300
FB100505T-221Y-S-2	220	±25%	100	0.30	800
FB100505T-241Y-S	240	±25%	100	0.30	500
FB100505T-301Y-S	300	±25%	100	0.75	100
FB100505T-301Y-S-1	300	±25%	100	0.45	400
FB100505T-301Y-S-2	300	±25%	100	0.80	200
FB100505T-331Y-S	330	±25%	100	0.75	100
FB100505T-331Y-S-1	330	±25%	100	0.20	800
FB100505T-331Y-S-2	330	±25%	100	0.28	700
FB100505T-431Y-S	430	±25%	100	0.50	350
FB100505T-471Y-S	470	±25%	100	0.90	100
FB100505T-471Y-S-1	470	±25%	100	0.60	300
FB100505T-501Y-S	500	±25%	100	1.00	100
FB100505T-601Y-S	600	±25%	100	1.10	50
FB100505T-601Y-S-1	600	±25%	100	0.60	300
FB100505T-601Y-S-2	600	±25%	100	0.80	600
FB100505T-102Y-S	1000	±25%	100	1.50	50
FB100505T-102Y-S-1	1000	±25%	100	0.80	250
FB100505T-102Y-S-2	1000	±25%	100	0.58	300
FB100505T-102Y-S-3	1000	±25%	100	0.49	350
FB100505T-152Y-S	1500	±25%	100	0.80	250
FB100505T-182Y-S	1800	±25%	100	0.80	250

FB160808 (0603)

PART NUMBER	IMPEDANCE (Ω)	TOLERANCE	TEST FREQUENCY (MHz)	DC RESISTANCE Ω (MAX)	RATED CURRENT mA (MAX) at 85°C
FB160808T-050Y-S-1	5	±25%	100	0.08	700
FB160808T-070Y-S-1	7	±25%	100	0.10	900
FB160808T-100Y-S	10	±25%	100	0.05	600
FB160808T-100Y-S-1	10	±25%	100	0.10	900
FB160808T-190Y-S	19	±25%	100	0.10	400
FB160808T-200Y-S	20	±25%	100	0.25	500
FB160808T-300Y-S	30	±25%	100	0.20	500
FB160808T-300Y-S-1	30	±25%	100	0.08	600
FB160808T-300Y-S-2	30	±25%	100	0.20	700
FB160808T-310Y-S	300	±25%	100	0.10	400
FB160808T-520Y-S	52	±25%	100	0.15	400
FB160808T-600Y-S	60	±25%	100	0.15	400
FB160808T-600Y-S-1	60	±25%	100	0.10	500
FB160808T-600Y-S-2	60	±25%	100	0.10	600
FB160808T-680Y-S-1	68	±25%	100	0.10	700



STANDARD ELECTRICAL SPECIFICATIONS (FOR GENERAL SIGNAL LINE)

FB160808 (0603) (CONT)

PART NUMBER	IMPEDANCE (Ω)	TOLERANCE	TEST FREQUENCY (MHz)	DC RESISTANCE Ω (MAX)	RATED CURRENT mA (MAX) at 85°C
FB160808T-700Y-S	70	$\pm 25\%$	100	0.15	400
FB160808T-750Y-S	75	$\pm 25\%$	100	0.15	400
FB160808T-750Y-S-1	75	$\pm 25\%$	100	0.35	500
FB160808T-800Y-S	80	$\pm 25\%$	100	0.15	400
FB160808T-800Y-S-1	80	$\pm 25\%$	100	0.10	600
FB160808T-800Y-S-2	80	$\pm 25\%$	100	0.20	700
FB160808T-101Y-S	100	$\pm 25\%$	100	0.15	400
FB160808T-121Y-S	120	$\pm 25\%$	100	0.15	400
FB160808T-121Y-S-1	120	$\pm 25\%$	100	0.10	800
FB160808T-151Y-S	150	$\pm 25\%$	100	0.15	400
FB160808T-181Y-S	180	$\pm 25\%$	100	0.20	400
FB160808T-201Y-S	200	$\pm 25\%$	100	0.20	400
FB160808T-221Y-S	220	$\pm 25\%$	100	0.20	400
FB160808T-221Y-S-1	220	$\pm 25\%$	100	0.30	550
FB160808T-241Y-S	240	$\pm 25\%$	100	0.17	500
FB160808T-301Y-S	300	$\pm 25\%$	100	0.30	400
FB160808T-301Y-S-1	300	$\pm 25\%$	100	0.35	450
FB160808T-301Y-S-2	300	$\pm 25\%$	100	0.35	500
FB160808T-331Y-S	330	$\pm 25\%$	100	0.30	500
FB160808T-401Y-S	400	$\pm 25\%$	100	0.30	400
FB160808T-401Y-S-1	400	$\pm 25\%$	100	0.20	500
FB160808T-421Y-S	420	$\pm 25\%$	100	0.30	400
FB160808T-451Y-S	450	$\pm 25\%$	100	0.30	400
FB160808T-471Y-S	470	$\pm 25\%$	100	0.45	400
FB160808T-471Y-S-1	470	$\pm 25\%$	100	0.45	500
FB160808T-501Y-S	500	$\pm 25\%$	100	0.35	400
FB160808T-601Y-S	600	$\pm 25\%$	100	0.40	450
FB160808T-601Y-S-1	600	$\pm 25\%$	100	0.50	500
FB160808T-751Y-S	750	$\pm 25\%$	100	0.15	400
FB160808T-102Y-S	1000	$\pm 25\%$	100	0.55	300
FB160808T-102Y-S-1	1000	$\pm 25\%$	100	0.25	800
FB160808T-102Y-S-2	1000	$\pm 25\%$	100	0.70	500
FB160808T-152Y-S	1500	$\pm 25\%$	100	0.60	200
FB160808T-152Y-S-1	1500	$\pm 25\%$	100	1.00	300
FB160808T-152Y-S-2	1500	$\pm 25\%$	100	0.50	500
FB160808T-182Y-S	1800	$\pm 25\%$	100	0.70	100
FB160808T-182Y-S-1	1800	$\pm 25\%$	100	1.00	200
FB160808T-202Y-S	2000	$\pm 25\%$	100	1.00	100
FB160808T-252Y-S	2500	$\pm 25\%$	100	0.70	100
FB160808T-252Y-S-1	2500	$\pm 25\%$	200	0.70	100
FB160808T-202Y-S	2000	$\pm 25\%$	100	1.00	100
FB160808T-252Y-S	2500	$\pm 25\%$	100	0.70	100
FB160808T-252Y-S-1	2500	$\pm 25\%$	200	0.70	100





STANDARD ELECTRICAL SPECIFICATIONS (FOR GENERAL SIGNAL LINE)

FB201209 (0805)

PART NUMBER	IMPEDANCE (Ω)	TOLERANCE	TEST FREQUENCY (MHz)	DC RESISTANCE Ω (MAX)	RATED CURRENT mA (MAX) at 85°C
FB201209T-050Y-S	5	±25%	100	0.07	500
FB201209T-070Y-S	7	±25%	100	0.07	500
FB201209T-100Y-S	10	±25%	100	0.07	500
FB201209T-110Y-S	11	±25%	100	0.10	500
FB201209T-130Y-S	13	±25%	100	0.08	500
FB201209T-170Y-S	17	±25%	100	0.10	300
FB201209T-260Y-S	26	±25%	100	0.10	300
FB201209T-300Y-S	30	±25%	100	0.10	300
FB201209T-300Y-S-1	30	±25%	100	0.05	800
FB201209T-310Y-S	31	±25%	100	0.10	300
FB201209T-320Y-S	32	±25%	100	0.15	300
FB201209T-330Y-S	33	±25%	100	0.10	300
FB201209T-400Y-S	40	±25%	100	0.05	800
FB201209T-520Y-S	52	±25%	100	0.15	300
FB201209T-600Y-S	60	±25%	100	0.15	300
FB201209T-600Y-S-1	60	±25%	100	0.15	800
FB201209T-600Y-S-2	60	±25%	100	0.10	900
FB201209T-700Y-S	70	±25%	100	0.20	300
FB201209T-750Y-S	75	±25%	100	0.20	300
FB201209T-800Y-S	80	±25%	100	0.15	300
FB201209T-800Y-S-1	80	±25%	100	0.15	800
FB201209T-101Y-S	100	±25%	100	0.20	300
FB201209T-121Y-S	120	±25%	100	0.20	300
FB201209T-121Y-S-1	120	±25%	100	0.15	800
FB201209T-151Y-S	150	±25%	100	0.20	300
FB201209T-151Y-S-1	150	±25%	100	0.10	800
FB201209T-201Y-S	200	±25%	100	0.25	300
FB201209T-221Y-S	220	±25%	100	0.25	300
FB201209T-221Y-S-1	220	±25%	100	0.20	500
FB201209T-221Y-S-2	220	±25%	100	0.30	750
FB201209T-301Y-S	300	±25%	100	0.25	300
FB201209T-301Y-S-1	300	±25%	100	0.20	500
FB201209T-301Y-S-2	300	±25%	100	0.30	700
FB201209T-331Y-S	330	±25%	100	0.25	300
FB201209T-401Y-S	400	±25%	100	0.30	300
FB201209T-471Y-S	470	±25%	100	0.18	700
FB201209T-531Y-S	530	±25%	100	0.35	300
FB201209T-601Y-S	600	±25%	100	0.25	200
FB201209T-601Y-S-1	600	±25%	100	0.30	500
FB201209T-751Y-S	750	±25%	100	0.20	300
FB201209T-102Y-S	1000	±25%	100	0.45	300
FB201209T-102Y-S-1	1000	±25%	100	0.45	400
FB201209T-122Y-S	1200	±25%	100	0.40	200
FB201209T-152Y-S	1500	±25%	100	0.70	300
FB201209T-182Y-S	1800	±25%	100	0.40	200



STANDARD ELECTRICAL SPECIFICATIONS (FOR GENERAL SIGNAL LINE)

FB201209 (0805) (CONT.)

PART NUMBER	IMPEDANCE (Ω)	TOLERANCE	TEST FREQUENCY (MHz)	DC RESISTANCE Ω (MAX)	RATED CURRENT mA (MAX) at 85°C
FB201209T-202Y-S	2000	$\pm 25\%$	100	0.50	500
FB201209T-222Y-S	2200	$\pm 25\%$	100	0.50	200
FB201209T-252Y-S	2500	$\pm 25\%$	100	0.60	200
FB201209T-272Y-S	2700	$\pm 25\%$	100	0.60	200

FB321611 (1206)

PART NUMBER	IMPEDANCE (Ω)	TOLERANCE	TEST FREQUENCY (MHz)	DC RESISTANCE Ω (MAX)	RATED CURRENT mA (MAX) at 85°C
FB321611T-050Y-S	5	$\pm 25\%$	100	0.07	500
FB321611T-070Y-S	7	$\pm 25\%$	100	0.07	500
FB321611T-190Y-S	19	$\pm 25\%$	100	0.10	800
FB321611T-250Y-S	25	$\pm 25\%$	100	0.10	500
FB321611T-260Y-S	26	$\pm 25\%$	100	0.10	800
FB321611T-310Y-S	31	$\pm 25\%$	100	0.10	800
FB321611T-320Y-S	32	$\pm 25\%$	100	0.10	800
FB321611T-500Y-S	50	$\pm 25\%$	100	0.15	800
FB321611T-520Y-S	52	$\pm 25\%$	100	0.15	800
FB321611T-550Y-S	55	$\pm 25\%$	100	0.15	500
FB321611T-600Y-S	60	$\pm 25\%$	100	0.20	500
FB321611T-700Y-S	70	$\pm 25\%$	100	0.20	500
FB321611T-700Y-S-1	70	$\pm 25\%$	100	0.10	800
FB321611T-900Y-S	90	$\pm 25\%$	100	0.15	500
FB321611T-101Y-S	100	$\pm 25\%$	100	0.20	450
FB321611T-121Y-S	120	$\pm 25\%$	100	0.20	450
FB321611T-121Y-S-1	120	$\pm 25\%$	100	0.15	600
FB321611T-121Y-S-2	120	$\pm 25\%$	100	0.15	900
FB321611T-151Y-S	150	$\pm 25\%$	100	0.20	450
FB321611T-181Y-S	180	$\pm 25\%$	100	0.20	350
FB321611T-201Y-S	200	$\pm 25\%$	100	0.25	350
FB321611T-221Y-S	220	$\pm 25\%$	100	0.20	350
FB321611T-221Y-S-1	220	$\pm 25\%$	100	0.35	700
FB321611T-301Y-S	300	$\pm 25\%$	100	0.20	350
FB321611T-401Y-S	400	$\pm 25\%$	100	0.25	350
FB321611T-501Y-S	500	$\pm 25\%$	100	0.25	350
FB321611T-601Y-S	600	$\pm 25\%$	100	0.25	350
FB321611T-601Y-S-1	600	$\pm 25\%$	100	0.25	500
FB321611T-751Y-S	750	$\pm 25\%$	100	0.30	350
FB321611T-801Y-S	800	$\pm 25\%$	100	0.30	350
FB321611T-102Y-S	1000	$\pm 25\%$	100	0.35	350
FB321611T-102Y-S-1	1000	$\pm 25\%$	100	0.40	500
FB321611T-122Y-S	1200	$\pm 25\%$	100	0.35	350
FB321611T-122Y-S-1	1200	$\pm 25\%$	100	0.40	500
FB321611T-152Y-S	1500	$\pm 25\%$	100	0.40	350
FB321611T-152Y-S-1	1500	$\pm 25\%$	100	0.20	800
FB321611T-182Y-S	1800	$\pm 25\%$	100	0.40	350



STANDARD ELECTRICAL SPECIFICATIONS (FOR GENERAL SIGNAL LINE)

FB321616 (1206)

PART NUMBER	IMPEDANCE (Ω)	TOLERANCE	TEST FREQUENCY (MHz)	DC RESISTANCE Ω (MAX)	RATED CURRENT mA (MAX) at 85°C
FB321616T-250Y-S	25	±25%	100	0.10	500
FB321616T-600Y-S	60	±25%	100	0.20	500
FB321616T-700Y-S	70	±25%	100	0.20	500

FB322513 (1210)

PART NUMBER	IMPEDANCE (Ω)	TOLERANCE	TEST FREQUENCY (MHz)	DC RESISTANCE Ω (MAX)	RATED CURRENT mA (MAX) at 85°C
FB322513T-310Y-S	31	±25%	100	0.10	500
FB322513T-320Y-S	32	±25%	100	0.10	500
FB322513T-520Y-S	52	±25%	100	0.30	400
FB322513T-600Y-S	60	±25%	100	0.30	400
FB322513T-600Y-S-1	60	±25%	100	0.30	800
FB322513T-650Y-S	65	±25%	100	0.30	400
FB322513T-900Y-S	90	±25%	100	0.30	800
FB322513T-121Y-S	120	±25%	100	0.30	400
FB322513T-201Y-S	200	±25%	100	0.45	200

FB451616 (1806)

PART NUMBER	IMPEDANCE (Ω)	TOLERANCE	TEST FREQUENCY (MHz)	DC RESISTANCE Ω (MAX)	RATED CURRENT mA (MAX) at 85°C
FB451616T-600Y-S	60	±25%	100	0.20	500
FB451616T-800Y-S	80	±25%	100	0.30	400
FB451616T-800Y-S-1	80	±25%	100	0.10	800
FB451616T-101Y-S	100	±25%	100	0.30	400
FB451616T-151Y-S	150	±25%	100	0.50	200
FB451616T-151Y-S-1	150	±25%	100	0.30	800
FB451616T-601Y-S	600	±25%	100	0.80	200

FB453215 (1812)

PART NUMBER	IMPEDANCE (Ω)	TOLERANCE	TEST FREQUENCY (MHz)	DC RESISTANCE Ω (MAX)	RATED CURRENT mA (MAX) at 85°C
FB453215T-310Y-S	31	±25%	100	0.10	500
FB453215T-600Y-S	60	±25%	100	0.20	500
FB453215T-700Y-S	70	±25%	100	0.40	800
FB453215T-800Y-S	80	±25%	100	0.40	800
FB453215T-950Y-S	95	±25%	100	0.20	500
FB453215T-121Y-S	120	±25%	100	0.20	500
FB453215T-121Y-S-1	120	±25%	100	0.40	800
FB453215T-151Y-S	150	±25%	100	0.20	500
FB453215T-151Y-S-1	150	±25%	100	0.30	800
FB453215T-471Y-S	470	±25%	100	0.20	500



ENVIRONMENTAL CHARACTERISTICS

ELECTRICAL PERFORMANCE TEST

ITEM	SPECIFICATION	TEST METHODS
Impedance	refer to standard electrical spec.	- HP4286A
DCR		- HP 4338 digital mili-ohm meter

MECHANICAL PERFORMANCE TEST

ITEM	SPECIFICATION	TEST METHODS
Substrate Bending Test	<ul style="list-style-type: none"> - Without deformation cases - Impedance: within $\pm 30\%$ of initial value - DC Resistance shall be satisfied 	<ul style="list-style-type: none"> - Test device shall be soldered on the substrate - Substrate Dimension: 100x40x0.8mm - Deflection: 3.0mm - Keeping Time: 10sec and then return
Vibration	<ul style="list-style-type: none"> - Appearance: No damage - Impedance: within $\pm 30\%$ of initial value - DC Resistance shall be satisfied 	<ul style="list-style-type: none"> - Test device shall be soldered on the substrate - Oscillation Frequency : 10 to 55 to 10Hz for 1min - Amplitude : 1.5 mm(peak-peak) - Time : 2 hrs for each axis (X,Y&Z), total 6 hrs
Resistance to Soldering Heat	<ul style="list-style-type: none"> - No visible damage - Electrical characteristics and mechanical characteristics shall be satisfied 	<ul style="list-style-type: none"> - Solder temp: $265 \pm 5^\circ\text{C}$ - Immersion time: $6 \pm 1\text{sec}$ - Preheating: 100°C to 150°C, 1 minute - Measured after exposure in the room condition for 24hrs - Solder: Sn-3Ag-0.5Cu
Solderability	<ul style="list-style-type: none"> - 95% min. coverage of all metallized area 	<ul style="list-style-type: none"> - Solder Temperature: $240 \pm 5^\circ\text{C}$ - Immersion Time: $3 \pm 1\text{sec}$ - Solder: Sn-3Ag-0.5Cu
Terminal Strength	<ul style="list-style-type: none"> - Without deformation cases - Impedance: within $\pm 30\%$ of initial value - DC Resistance shall be satisfied 	<ul style="list-style-type: none"> - Solder chip on PCB and applied 10N (1.02Kgf) for 10 sec
Temperature Cycle		<ul style="list-style-type: none"> One cycle: <ul style="list-style-type: none"> step1: $-55 \pm 3^\circ\text{C}$ for $30 \pm 3\text{min}$ step2: standard atmospheric conditions 5s or less step3: $125 \pm 2^\circ\text{C}$ for $30 \pm 3\text{min}$ step4: standard atmospheric conditions 5s or less - Total: 100cycles - Measured after exposure in the room condition for 24hrs
Humidity Resistance	<ul style="list-style-type: none"> - Appearance: No damage - Impedance: within $\pm 30\%$ of initial value DC Resistance shall be satisfied 	<ul style="list-style-type: none"> - Temperature: $60 \pm 2^\circ\text{C}$ - Relative Humidity: 90 ~ 95% - Applied Current: Rated Current(maximum value) - Time: $1008 \pm 12\text{hrs}$ - Measured after exposure in the room condition for 24 hrs
High Temperature Resistance		<ul style="list-style-type: none"> - Temperature: $125 \pm 2^\circ\text{C}$ - Applied Current: Rated Current(maximum value) - Time: $1008 \pm 12\text{hrs}$ - Measured after exposure in the room condition for 24 hrs
Low Temperature Storage Life Test		<ul style="list-style-type: none"> - Temperature: $-55 \pm 2^\circ\text{C}$ - Time: $1008 \pm 12\text{hrs}$ - Measured after exposure in the room condition for 24 hrs
Thermal Shock		<ul style="list-style-type: none"> - $-55^\circ\text{C} \sim 125^\circ\text{C}$ kept stabilized for 30 minutes each for 100 cycles - Measured after exposure in the room condition for 24 hrs

- Operating Temperature: $-55^\circ\text{C} \sim 125^\circ\text{C}$
 - Storage Temperature: $15 \sim 28^\circ\text{C}$; Humidity < 80%RH



- Reel Specifications

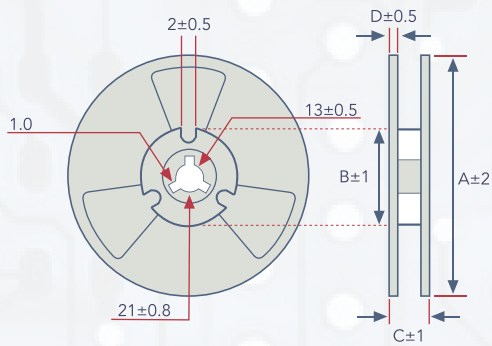

- Tape Specifications

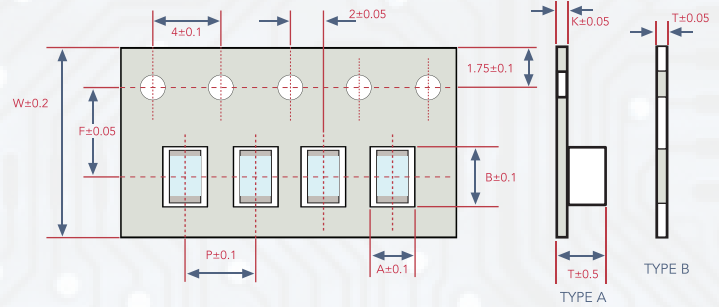

- Tape Material

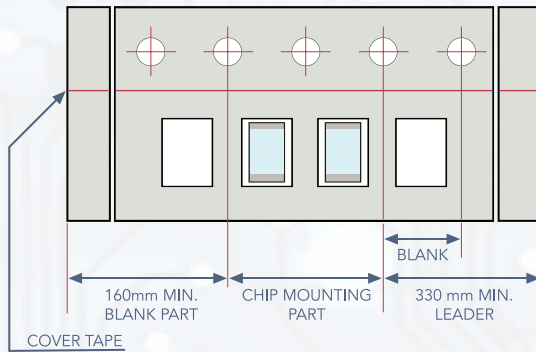

- Recommended Pattern

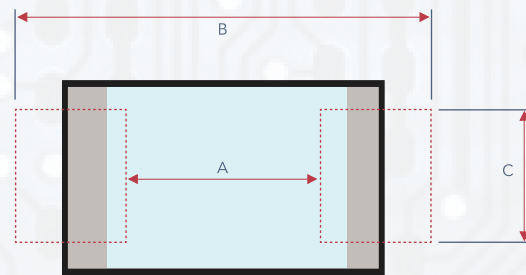

TYPE	TAPE DIMENSIONS								REEL DIMENSIONS				RECOMMENDED PATTERN			QUANTITY (EA)
	A	B	T	W	P	F	K	TAPE TYPE	A	B	C	D	A	B	C	
FB060303	0.38	0.68	1.10	8.0	2.0	3.5	-	B	178	60	10	2	0.25	0.69	0.32	15000
FB100505	0.65	1.15	0.80	8.0	2.0	3.5	-	B	178	60	10	2	0.50	2.10	0.55	10000
FB160808	1.10	1.90	1.10	8.0	4.0	3.5	-	B	178	60	10	2	0.60	2.60	0.80	4000
FB201209	1.55	2.30	1.20	8.0	4.0	3.5	-	B	178	60	10	2	0.66	3.23	1.47	4000
FB321611	1.90	3.50	1.40	8.0	4.0	3.5	0.2	A	178	60	10	2	2.20	4.40	2.06	3000
FB321616	1.88	3.64	1.90	8.0	4.0	3.5	0.2	A	178	60	10	2	2.20	4.2-5.2	1.2	2000
FB322513	2.90	3.60	1.70	8.0	4.0	3.5	0.2	A	178	60	10	2	2.13	4.06	2.74	2000
FB451616	2.90	4.90	1.40	12	4.0	5.5	0.3	A	178	60	14	2	2.70	5.70	2.24	2000
FB453215	3.60	4.90	2.05	12	8.0	5.5	0.3	A	178	60	14	2	2.57	5.90	4.22	1000

SOLDERING CONDITION

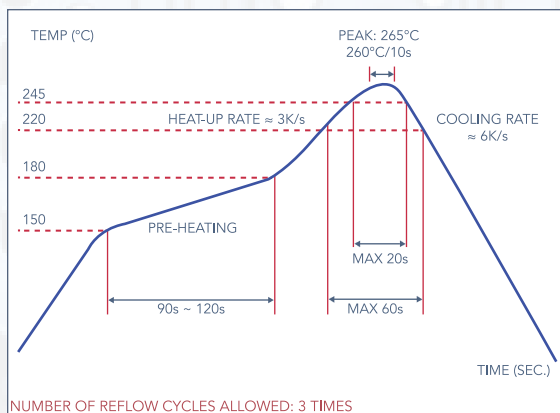

IR Reflow Soldering

(1) Time of IR reflow soldering at maximum temperature point 260°C zzz: 10s

(2) Time of soldering iron at maximum temperature point 280°C : 3s