

MULTILAYER CERAMIC CHIP CAPACITOR

- GMX SERIES - SOFT TERMINATION

INTRODUCTION

- Multilayer Ceramic Chip Capacitors supplied in bulk or tape & reel package are ideally suitable for thick-film hybrid circuits and automatic surface mounting on any printed circuit boards.
- GMX series use a special material between nickel-barrier and ceramic body. It provides excellent performance to guard against bending stress occurred during process and provide more security for PCB process.
- The nickel-barrier terminations are consisted of a nickel barrier layer over the silver metallization and then finished by electroplated solder layer to ensure the terminations have good solderability. The nickel barrier layer in terminations prevents the dissolution of termination when extended immersion in molten solder at elevated solder temperature.

APPLICATIONS

- For general digital circuit.
- For power supply bypass capacitors.
- For consumer electronics.
- For telecommunication.
- DC to DC converter.

FEATURES

- High performance to withstanding 3~5mm of substrate bending test guarantee.
- A wide selection of sizes is available.
- High capacitance in given case size.
- Capacitor with lead-free termination (pure Tin).
- Reduction in PCB bend failure.
- High reliability and stability.
- RoHS & HALOGEN FREE.

ORDERING INFORMATION

GMX	31	X7R	104	K	100	CT
SERIES	SIZE	DIELECTRIC	CAPACITANCE	TOLERANCE	RATED VOLTAGE	PACKAGING
Anti-Bend General Purpose Product	04 - 0402 (1005) 10 - 0603 (1608) 21 - 0805 (2012) 31 - 1206 (3216) 32 - 1210 (3225) 40 - 1808 (4520) 43 - 1812 (4532) 45 - 1825 (4563) 55 - 2220 (5750) 57 - 2225 (5763)	CG - COG X7R - X7R	R47 - 0.47pF 0R5 - 0.5pF 100 - 10x10 ³ -10pF 102 - 10x10 ² -1000pF 104 - 10x10 ⁴ -100nF 106 - 10x10 ⁶ -10µF	A: ±0.05pF B: ±0.10pF C: ±0.25 pF D: ±0.50 pF F: ±1 % G: ±2% H: ±3% I: -10% ~ 0% J: ±5% K: ±10% L: 0% ~ +10% M: ±20% N: -5% ~ +10% P: ±0.02 pF O: ±0.03 pF Z: -20% ~ +80% X: +10% ~ +20%	6R3 - 6.3Vdc 10 - 10Vdc 16 - 16Vdc 25 - 25Vdc 35 - 35Vdc 50 - 50Vdc 100 - 100Vdc 200 - 200Vdc 250 - 250Vdc 400 - 400Vdc 500 - 500Vdc 630 - 630Vdc 1K0 - 1000Vdc 1K5 - 1500Vdc 2K0 - 2000Vdc 3K0 - 3000Vdc 4K0 - 4000Vdc 5K0 - 5000Vdc	CT -Tape and 7" Reel CTD - Tape and 10" Reel CTG - Tape and 13" Reel

EXTERNAL DIMENSION

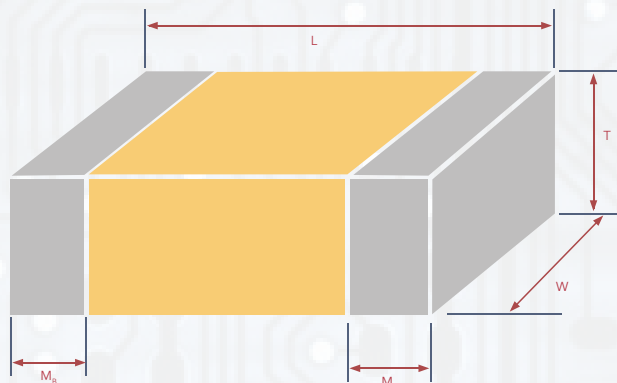

UNIT: MM

SIZE	INCH	L	W	t	M _b
0402	1005	1.00±0.20	0.50±0.20	SEE TABLE BELOW	0.25 +0.05/-0.10
0603	1608	1.60±0.20	0.80±0.20		0.40±0.15
0805	2012	2.10±0.20	1.25±0.20		0.50±0.20
1206	3216	3.30±0.30	1.60±0.20 1.60 +0.30/-0.10		0.60±0.20
1210	3225	3.30±0.40	2.50±0.30		0.75±0.35
1808	4520	4.60±0.50	2.00±0.25		0.75±0.35
1812	4532	4.60±0.50	3.20±0.30		0.75±0.35
1825	4563	4.60±0.50	6.30±0.40		0.75±0.35
2220	5750	5.70±0.50	5.00±0.40		0.85±0.35
2225	5763	5.70±0.50	6.30±0.40		0.85±0.35

GENERAL ELECTRICAL DATA

DIELECTRIC	C0G	X7R											
SIZE	0402, 0603, 0805, 1206, 1210, 1808, 1812, 1825, 2220, 2225	0402, 0603, 0805, 1206, 1210, 1808, 1812, 1825, 2220, 2225											
RATED VOLTAGE (WVDC)	10V, 16V, 25V, 50V, 100V, 200V, 250V, 500V, 630V, 1KV, 1.5KV, 2KV, 3KV, 4KV	6.3V, 10V, 16V, 25V, 50V, 100V, 200V, 250V, 500V, 630V, 1KV, 1.5KV, 2KV, 3KV, 4KV, 5KV											
CAPACITANCE RANGE	0.1pF ~ 100nF	100pF ~ 47μF											
CAPACITANCE TOLERANCE	SEE ORDERING INFORMATION	SEE ORDERING INFORMATION											
TAN δ	<table border="1"> <thead> <tr> <th>CAP. RANGE</th> <th>Q SPEC</th> </tr> </thead> <tbody> <tr> <td>CAP. <30pF</td> <td>Q_z≥400+20°C</td> </tr> <tr> <td>CAP. ≥30pF</td> <td>Q_z≥1000</td> </tr> </tbody> </table>	CAP. RANGE	Q SPEC	CAP. <30pF	Q _z ≥400+20°C	CAP. ≥30pF	Q _z ≥1000	SEE RELIABILITY TEST CONDITIONS AND REQUIREMENTS BELOW					
CAP. RANGE	Q SPEC												
CAP. <30pF	Q _z ≥400+20°C												
CAP. ≥30pF	Q _z ≥1000												
CAPACITANCE & TAN δ TEST CONDITION	For 25°C at ambient temperature	Preconditioning for Class II MLCC: Perform a heat treatment at 150±10°C for 1 hour, then leave in ambient condition for 24±2 hours before measurement											
	<table border="1"> <thead> <tr> <th>CAP. RANGE</th> <th>TEST CONDITION</th> </tr> </thead> <tbody> <tr> <td>Cap.≤1000pF</td> <td>1.0±0.2Vrms, 1.0MHz±10%</td> </tr> <tr> <td>Cap.>1000pF</td> <td>1.0±0.2Vrms, 1.0KHz±10%</td> </tr> </tbody> </table>	CAP. RANGE	TEST CONDITION	Cap.≤1000pF	1.0±0.2Vrms, 1.0MHz±10%	Cap.>1000pF	1.0±0.2Vrms, 1.0KHz±10%	<table border="1"> <thead> <tr> <th>CAP. RANGE</th> <th>TEST CONDITION</th> </tr> </thead> <tbody> <tr> <td>Cap.≤10μF</td> <td>1.0±0.2Vrms, 1.0KHz±10%</td> </tr> <tr> <td>Cap.>10μF</td> <td>0.5±0.2Vrms, 120Hz±20%</td> </tr> </tbody> </table>	CAP. RANGE	TEST CONDITION	Cap.≤10μF	1.0±0.2Vrms, 1.0KHz±10%	Cap.>10μF
CAP. RANGE	TEST CONDITION												
Cap.≤1000pF	1.0±0.2Vrms, 1.0MHz±10%												
Cap.>1000pF	1.0±0.2Vrms, 1.0KHz±10%												
CAP. RANGE	TEST CONDITION												
Cap.≤10μF	1.0±0.2Vrms, 1.0KHz±10%												
Cap.>10μF	0.5±0.2Vrms, 120Hz±20%												
INSULATION RESISTANCE	≥10GΩ or RxC≥500Ω-F, whichever is smaller	≥10GΩ or RxC≥100Ω-F, whichever is smaller											
OPERATING TEMPERATURE	-55°C to +125°C	-55°C to +125°C											
TEMPERATURE COEFFICIENT	±30ppm/°C	±15%											
TERMINATION	Cu/Ag polymer/Ni/Sn(lead-free termination)	Cu/Ag polymer/Ni/Sn(lead-free termination)											

THICKNESS DESCRIPTION

CODE	DESCRIPTON	CODE	DESCRIPTON	CODE	DESCRIPTON
A	0.60 ± 0.10 mm	I	1.25 ± 0.20 mm	Q	0.50 +0.02/-0.05 mm
B	0.8 + 0.15/-0.10 mm	J	1.15 ± 0.15 mm	R	3.10 ± 0.30 mm
C	1.25 ± 0.10 mm	K	0.50 ± 0.20 mm	S	0.80 ± 0.07 mm
D	1.40 ± 0.15 mm	L	0.30 ± 0.03 mm	T	0.85 ± 0.10 mm
E	1.60 ± 0.20 mm	M	0.95 ± 0.10 mm	U	0.50 ± 0.10 mm
F	2.00 ± 0.20 mm	N	0.50 ± 0.05 mm	V	0.20 ± 0.02 mm
G	2.50 ± 0.30 mm	O	3.50 ± 0.20 mm	X	0.80 ± 0.10 mm
H	2.80 ± 0.30 mm	P	1.60 +0.3/-0.10 mm	Z	0.25 ± 0.03 mm





CAPACITANCE RANGE

DIELECTRIC		COG																						
SIZE		0402					0603					0805												
RATED VOLTAGE		10	16	25	50	100	10	16	25	50	100	200	250	10	16	25	50	100	200	250	500	630	1000	
CAPACITANCE RANGE	0.1pF	OR1	K	K	K	K																		
	0.2pF	OR2	K	K	K	K																		
	0.3pF	OR3	K	K	K	K		S	S	S	S	S												
	0.4pF	OR4	K	K	K	K		S	S	S	S	S												
	0.5pF	OR5	K	K	K	K	K	S	S	S	S	S	S	S	A	A	A	A	A	A	A	A	A	C
	0.6pF	OR6	K	K	K	K	K	S	S	S	S	S	S	S	A	A	A	A	A	A	A	A	A	C
	0.7pF	OR7	K	K	K	K	K	S	S	S	S	S	S	S	A	A	A	A	A	A	A	A	A	C
	0.8pF	OR8	K	K	K	K	K	S	S	S	S	S	S	S	A	A	A	A	A	A	A	A	A	C
	0.9pF	OR9	K	K	K	K	K	S	S	S	S	S	S	S	A	A	A	A	A	A	A	A	A	C
	1.0pF	1R0	K	K	K	K	K	S	S	S	S	S	S	S	A	A	A	A	A	A	A	A	A	C
	1.2pF	1R2	K	K	K	K	K	S	S	S	S	S	S	S	A	A	A	A	A	A	A	A	A	C
	1.5pF	1R5	K	K	K	K	K	S	S	S	S	S	S	S	A	A	A	A	A	A	A	A	A	C
	1.8pF	1R8	K	K	K	K	K	S	S	S	S	S	S	S	A	A	A	A	A	A	A	A	A	C
	2.2pF	2R2	K	K	K	K	K	S	S	S	S	S	S	S	A	A	A	A	A	A	A	A	A	C
	2.7pF	2R7	K	K	K	K	K	S	S	S	S	S	S	S	A	A	A	A	A	A	A	A	A	C
	3.3pF	3R3	K	K	K	K	K	S	S	S	S	S	S	S	A	A	A	A	A	A	A	A	A	C
	3.9pF	3R9	K	K	K	K	K	S	S	S	S	S	S	S	A	A	A	A	A	A	A	A	A	C
	4.7pF	4R7	K	K	K	K	K	S	S	S	S	S	S	S	A	A	A	A	A	A	A	A	A	C
	5.6pF	5R6	K	K	K	K	K	S	S	S	S	S	S	S	A	A	A	A	A	A	A	A	A	C
	6.8pF	6R8	K	K	K	K	K	S	S	S	S	S	S	S	A	A	A	A	A	A	A	A	A	C
	8.2pF	8R2	K	K	K	K	K	S	S	S	S	S	S	S	A	A	A	A	A	A	A	A	A	C
	10pF	100	K	K	K	K	K	S	S	S	S	S	S	S	A	A	A	A	A	A	A	A	A	C
	12pF	120	K	K	K	K	K	S	S	S	S	S	S	S	A	A	A	A	A	A	A	A	A	C
	15pF	150	K	K	K	K	K	S	S	S	S	S	S	S	A	A	A	A	A	A	A	A	A	C
	18pF	180	K	K	K	K	K	S	S	S	S	S	S	S	A	A	A	A	A	A	A	A	A	C
	22pF	220	K	K	K	K	K	S	S	S	S	S	S	S	A	A	A	A	A	A	A	A	A	C
	27pF	270	K	K	K	K	K	S	S	S	S	S	S	S	A	A	A	A	A	A	A	A	A	C
	33pF	330	K	K	K	K	K	S	S	S	S	S	S	S	A	A	A	A	A	A	A	A	A	C
	39pF	390	K	K	K	K	K	S	S	S	S	S	S	S	A	A	A	A	A	A	A	A	A	C
	47pF	470	K	K	K	K	K	S	S	S	S	S	S	S	A	A	A	A	A	A	A	A	A	C
	56pF	560	K	K	K	K	K	S	S	S	S	S	S	S	A	A	A	A	A	A	A	A	A	C
	68pF	680	K	K	K	K	K	S	S	S	S	S	S	S	A	A	A	A	A	A	A	A	A	C
	82pF	820	K	K	K	K	K	S	S	S	S	S	S	S	A	A	A	A	A	A	A	X	X	C
100pF	101	K	K	K	K	K	S	S	S	S	S	S	S	A	A	A	A	A	A	X	X	X	C	
120pF	121	K	K	K	K	K	S	S	S	S	S	S	S	A	A	A	A	A	A	X	C	C	C	
150pF	151	K	K	K	K	K	S	S	S	S	S	S	S	A	A	A	A	A	X	C	C	C	C	
180pF	181	K	K	K	K	K	S	S	S	S	S	S	S	A	A	A	A	A	X	C	C	C	C	
220pF	221	K	K	K	K	K	S	S	S	S	S	S	S	A	A	A	A	A	C	C	C	C	C	
270pF	271	K	K	K	K		S	S	S	S	S	B	B	A	A	A	A	A	C	C	C	C	C	
330pF	331	K	K	K	K		S	S	S	S	S	B	B	A	A	A	A	A	C	C	C	C	C	
390pF	391	K	K	K	K		S	S	S	S	S	B	B	X	X	X	X	X	C	C	C	C	C	
470pF	471	K	K	K	K		S	S	S	S	S	B	B	X	X	X	X	X	C	C	I	I		
560pF	561	K	K	K	K		S	S	S	S	S			X	X	X	X	X	C	C	I	I		
680pF	681	K	K	K	K		S	S	S	S	S			X	X	X	X	X	C	C	I	I		
820pF	821	K	K	K	K		S	S	S	S	S			X	X	X	X	X	C	C	I	I		
1,000pF	102	K	K	K	K		S	S	S	S	S			X	X	X	X	X	C	C	I	I		
1,200pF	122						B	B	B	B				X	X	X	X	X	C	C				
1,500pF	152						B	B	B	B				X	X	X	X	X	C	C				
1,800pF	182						B	B	B	B				X	X	X	X	X	C	C				
2,200pF	222						B	B	B	B				X	X	X	X	X	C	C				
2,700pF	272						B	B	B	B				C	C	C	C	C	C	C				
3,300pF	332						B	B	B	B				C	C	C	C	C						
3,900pF	392													C	C	C	C	C						
4,700pF	472													C	C	C	C							
5,600pF	562													C	C	C	C	C						
6,800pF	682													C	C	C								
8,200pF	822													C	C	C	C							
10000	103													C	C	C	C							
0.012uf	123																							

* ARC PROTECTION COATING

CODE	A	B	C	I	K	S	X
DESCRIPTION	0.60 ± 0.10 mm	0.8 + 0.15/-0.10 mm	1.25 ± 0.10 mm	1.25 ± 0.20 mm	0.50 ± 0.20 mm	0.80 ± 0.07 mm	0.80 ± 0.10 mm





CAPACITANCE RANGE

DIELECTRIC		COG																									
		1206												1210													
SIZE		10	16	25	50	100	200	250	500	630	1000	1500	2000	10	16	25	50	100	200	250	500	630	1000	1500	2000	3000	
RATED VOLTAGE		10	16	25	50	100	200	250	500	630	1000	1500	2000	10	16	25	50	100	200	250	500	630	1000	1500	2000	3000	
1.0pf	1R0				X																						
1.2pf	1R2	X	X	X	X	X		X																			
1.5pf	1R5	X	X	X	X	X	X	X	X	X	X	X	X														
1.8pf	1R8	X	X	X	X	X	X	X	X	X	X	X	X														
2.2pf	2R2	X	X	X	X	X	X	X	X	X	X	X	X														
2.7pf	2R7	X	X	X	X	X	X	X	X	X	X	X	X														
3.3pF	3R3	X	X	X	X	X	X	X	X	X	X	X	X														
3.9pf	3R9	X	X	X	X	X	X	X	X	X	X	X	X														
4.7pf	4R7	X	X	X	X	X	X	X	X	X	X	X	X														
5.0 pF	5R0	X	X	X	X	X	X	X	X	X	X	X	X														
5.6pF	5R6	X	X	X	X	X	X	X	X	X	X	X	X														
6.8pf	6R8	X	X	X	X	X	X	X	X	X	X	X	X														
8.2pf	8R2	X	X	X	X	X	X	X	X	X	X	X	X														
10pf	100	X	X	X	X	X	X	X	X	X	X	X	X	M	M	M	M	M	M	M	M	M	M	M	M	F	
12pF	120	X	X	X	X	X	X	X	X	X	X	X	X	M	M	M	M	M	M	M	M	M	M	M	M	F	
15pF	150	X	X	X	X	X	X	X	X	X	X	X	X	M	M	M	M	M	M	M	M	M	M	M	M	F	
18pF	180	X	X	X	X	X	X	X	X	X	X	X	X	M	M	M	M	M	M	M	M	M	M	M	M	F	
22pF	220	X	X	X	X	X	X	X	X	X	X	X	X	M	M	M	M	M	M	M	M	M	M	M	M	F	
27pF	270	X	X	X	X	X	X	X	X	X	X	X	X	M	M	M	M	M	M	M	M	M	M	M	M	F	
33pF	330	X	X	X	X	X	X	X	X	X	X	X	M	M	M	M	M	M	M	M	M	M	M	M	M	F	
39pF	390	X	X	X	X	X	X	X	X	X	X	X	M	M	M	M	M	M	M	M	M	M	M	M	M	F	
47pF	470	X	X	X	X	X	X	X	X	X	X	X	M	M	M	M	M	M	M	M	M	M	M	M	M	F	
56pF	560	X	X	X	X	X	X	X	X	X	X	X	M	C	C	M	M	M	M	M	M	M	M	M	M	C	F
68pF	680	X	X	X	X	X	X	X	X	X	X	X	M	C	C	M	M	M	M	M	M	M	M	M	M	C	F
82pF	820	X	X	X	X	X	X	X	X	X	X	X	C	C	C	M	M	M	M	M	M	M	M	M	M	C	F
100pF	101	X	X	X	X	X	X	X	X	X	X	X	C	C	C	M	M	M	M	M	M	M	M	M	M	C	F
120pF	121	X	X	X	X	X	X	X	X	X	X	X	C	E	E	M	M	M	M	M	M	M	M	M	M	C	F
150pF	151	X	X	X	X	X	X	X	X	X	X	X	C	E	E	M	M	M	M	M	M	M	M	M	M	C	F
180pF	181	X	X	X	X	X	X	X	X	X	X	X	E	E	E	M	M	M	M	M	M	M	M	M	M	C	F
220pF	221	X	X	X	X	X	X	X	X	X	X	X	E	E	E	M	M	M	M	M	M	M	M	M	M	E	F
270pF	271	X	X	X	X	X	X	X	M	M	M	E	P	P	M	M	M	M	M	M	M	M	M	M	E	F	G
330pF	331	X	X	X	X	X	X	X	M	M	M	E	P	P	M	M	M	M	M	M	M	M	M	M	E	G	G
390pF	391	X	X	X	X	X	X	X	M	M	M	E	P	P	M	M	M	M	M	M	M	M	M	M	E	G	G
470pF	471	X	X	X	X	X	X	X	M	M	M	E	E	E	M	M	M	M	M	M	M	M	M	M	E	G	G
560pF	561	X	X	X	X	X	X	M	C	C	C	E			M	M	M	M	M	M	M	M	M	M	E	G	G
680pF	681	X	X	X	X	X	X	M	C	C	C	E			M	M	M	M	M	M	M	M	M	M	E	G	G
820pF	821	X	X	X	X	X	M	E	E	E	E	E			M	M	M	M	M	M	M	M	M	M	E	G	G
1000pF	102	X	X	X	X	X	M	E	E	E	E	E			M	M	M	M	M	C	C	C	C	E	G	G	
1200pF	122	X	X	X	X	X	M	E	E	E	E	E			M	M	M	M	M	C	C	C	C	E	F	F	
1500pF	152	X	X	X	X	X	C	E	E	E	E	E			M	M	M	M	M	C	C	C	C	F	G	G	
1800pF	182	X	X	X	X	X	C	E	E	E	E	E			M	M	M	M	M	C	C	C	C	G	G	G	
2200pF	222	X	X	X	X	X	C	E	E	E	E	E			M	M	M	M	M	C	C	C	C	G			
2700pF	272	X	X	X	X	X	C	E	E	E	E	E			M	M	M	M	M	C	C	C	C	G			
3300pF	332	X	X	X	X	X	C	E	E	E	E	E			M	M	M	M	M	C	C	C	C	G			
3900pF	392	X	X	X	X	X	E	E	E	E	E	E			M	M	M	M	M	C	C	C	C	G			
4700pF	472	X	X	X	X	X	E	E	E	E	E	E			M	M	M	M	M	E	E	E	E	G			
5600pF	562	X	X	X	X	X	E	E	E	E	E	E			M	M	M	M	C	E	E	E	E	G			
6800pF	682	M	M	M	M	M	E	E	E	C	E	E			M	M	M	M	C	E	E	E	E	G			
8200pF	822	C	C	C	C	C	E	E	E	E	E	E			M	M	M	M	C	E	E	E	E	G			
0.010uF	103	C	C	C	C	C	E	E	E	E	E	E			M	M	M	M	E	F	F	F	F	G			
0.012uF	123	P	P	P	P	P									C	C	C	C	E	F	F	F	F	G			
0.015uF	153	P	P	P	P	P									C	C	C	C	F	F	F	F	F	G			
0.018uF	183	P	P	P	P	P									F	F	F	F	F	F	F	F	F	G			
0.022uF	223	P	P	P	P	P									F	F	F	F	F	F	F	F	F	G			
0.027uF	273	P	P	P	P										F/G	F/G	F/G	F/G	F	F	F	G	G				
0.033uF	333	P	P	P	P										F/G	F/G	F/G	F/G	F		F	G	G				
0.039uF	393	P	P	P	P										F/G	F/G	F/G	F/G	F		F						
0.047uF	473														F	F	F	F	F	F	F						
0.056uF	563				B																						
0.068uF	683																										

* ARC PROTECTION COATING

CODE	B	C	E	F	G	M	P	X
DESCRIPTION	0.8 +0.15/-0.10	1.25 ± 0.10	1.60 ± 0.20	2.00 ± 0.20	2.50 ± 0.30	0.95 ± 0.10	1.60 +0.3/-0.10	0.80 ± 0.10



CAPACITANCE RANGE

DIELECTRIC		COG																								
		1808											1812													
SIZE	RATED VOLTAGE	25	50	100	200	250	500	630	1000	1500	2000	3000	4000	10	16	25	50	100	200	250	630	1000	1500	2000	3000	4000
		1.8pf	1R8																							
2.2pf	2R2	C	C	C	C	C	C	C	C	C	C	C	C													
2.7pf	2R7	C	C	C	C	C	C	C	C	C	C	C	C													
3.3pF	3R3	C	C	C	C	C	C	C	C	C	C	C	C													
3.9pf	3R9	C	C	C	C	C	C	C	C	C	C	C	C													
4.7pf	4R7	C	C	C	C	C	C	C	C	C	C	C	C													
5.0 pF	5R0	C	C	C	C	C	C	C	C	C	C	C	C													
5.6pF	5R6	C	C	C	C	C	C	C	C	C	C	C	C													
6.8pf	6R8	C	C	C	C	C	C	C	C	C	C	C	C													
8.2pf	8R2	C	C	C	C	C	C	C	C	C	C	C	C													
10pf	100	C	C	C	C	C	C	C	C	C	C	C	C	C	C	C	C	C	C	C	C	C	C	C	C	C
12pF	120	C	C	C	C	C	C	C	C	C	C	C	C	C	C	C	C	C	C	C	C	C	C	C	C	C
15pF	150	C	C	C	C	C	C	C	C	C	C	C	C	C	C	C	C	C	C	C	C	C	C	C	C	C
18pF	180	C	C	C	C	C	C	C	C	C	C	C	C	C	C	C	C	C	C	C	C	C	C	C	C	C
22pF	220	C	C	C	C	C	C	C	C	C	C	C	C	E	C	C	C	C	C	C	C	C	C	C	C	C
27pF	270	C	C	C	C	C	C	C	C	C	C	C	C	E	C	C	C	C	C	C	C	C	C	C	C	C
33pF	330	C	C	C	C	C	C	C	C	C	C	C	C	F	C	C	C	C	C	C	C	C	C	C	C	C*
39pF	390	C	C	C	C	C	C	C	C	C	C	C	C	F	C	C	C	C	C	C	C	C	C	C	C	C*
47pF	470	C	C	C	C	C	C	C	C	C	C	C	C		C	C	C	C	C	C	C	C	C	C	C	E*
56pF	560	C	C	C	C	C	C	C	C	C	C	C	C		C	C	C	C	C	C	C	C	C	C	C	E*
68pF	680	C	C	C	C	C	C	C	C	C	C	C	C		C	C	C	C	C	C	C	C	C	C	C	F*
82pF	820	C	C	C	C	C	C	C	C	C	C	C	C		C	C	C	C	C	C	C	C	C	C	C	F*
100pF	101	C	C	C	C	C	C	C	C	C	C	C	F		C	C	C	C	C	C	C	C	C	C	C	F*
120pF	121	C	C	C	C	C	C	C	C	C	C	C	F		C	C	C	C	C	C	C	C	C	C	C	G
150pF	151	C	C	C	C	C	C	C	C	C	F	F	F		C	C	C	C	C	C	C	C	C	C	C	
180pF	181	C	C	C	C	C	C	C	C	C	F	F	F		C	C	C	C	C	C	C	C	C	C	C	F
220pF	221	C	C	C	C	C	C	C	C	C	F	F	F		C	C	C	C	C	C	C	C	C	C	C	F
270pF	271	C	C	C	C	C	C	C	F	F	F	F		C	C	C	C	C	C	C	C	C	C	C	C	F
330pF	331	C	C	C	C	C	C	C	F	F	F	F		C	C	C	C	C	C	C	C	C	C	C	C	F
390pF	391	C	C	C	C	C	C	C	F	F	F	F		C	C	C	C	C	C	C	C	C	C	F	F	F
470pF	471	C	C	C	C	C	C	C	F	F	F	F		C	C	C	C	C	C	C	C	C	C	F	F	F
560pF	561	C	C	C	C	C	C	C	F	F	F			C	C	C	C	C	C	C	C	C	F	F	F	
680pF	681	C	C	C	C	C	C	C	F	F	F			C	C	C	C	C	C	C	C	C	F	F	F	
820pF	821	C	C	C	C	C	C	C	F	F	F			C	C	C	C	C	C	C	C	C	F	F	G	
1000pF	102	C	C	C	C	C	C	C	F	F	F			C	C	C	C	C	C	C	C	C	F	F	G	
1200pF	122	C	C	C	C	C	C	C	F	F	F			C	C	C	C	C	C	C	C	C	F	F	R	
1500pF	152	C	C	C	C	C	C	C	F	F	F			C	C	C	C	C	C	C	C	C	F	F		
1800pF	182	C	C	C	C	C	C	C	F	F	F			C	C	C	C	C	C	C	C	F	F	F		
2200pF	222	C	C	C	C	C	C	C	F					C	C	C	C	C	C	C	C	E	F	F		
2700pF	272	C	C	C	C	C	C	C	C					C	C	C	C	C	C	C	C	F	G	G		
3300pF	332	C	C	C	C	C	C	C	C					C	C	C	C	C	C	C	C	F	G	G		
3900pF	392	C	C	C	C	C								C	C	C	C	C	C	C	C	G				
4700pF	472	C	C	C	C	C								C	C	C	C	C	C	C	C	F/G				
5600pF	562	C	C	C	E	E								C	C	C	C	C	C	C	C	G				
6800pF	682	C	C	C	E	E								C	C	C	C	C	C	C	C					
8200pF	822	C	C	E	F	F								C	C	C	C	C	C	C	C					
0.010uF	103	C	C	E	F	F								C	C	C	C	C	C	C	C					
0.012uF	123	E	E											C	C	C	C	C	E	E	E					
0.015uF	153	E	E											C	C	C	C	C	E	E	E					
0.018uF	183	F	F											C	C	C	C	E	F	F	F					
0.022uF	223	F	F											C	C	C	C	E	F	F	F					
0.027uF	273													C	C	E	E	F	G	G						
0.033uF	333													C	C	E	E	F								
0.039uF	393															F	F	G								
0.047uF	473															F	F	G								
0.056uF	563															G	G									
0.068uF	683															G	G									
0.083uF	823															G	G									
0.010	104															G	G									

* ARC PROTECTION COATING

CODE	C	E	F	G	R
DESCRIPTION	1.25 ± 0.10	1.60 ± 0.20	2.00 ± 0.20	2.50 ± 0.30	3.10 ± 0.30





CAPACITANCE RANGE

DIELECTRIC			COG																						
SIZE			1825										2220												
RATED VOLTAGE			25	50	100	200	250	500	630	1000	1500	2000	3000	25	50	100	200	250	500	630	1000	1500	2000	3000	4000
CAPACITANCE RANGE	10	100	F	F	F	F	F	F	F	F	F	F	F	F	F	F	F	F	F	F	F	F	F	F	
	12	120	F	F	F	F	F	F	F	F	F	F	F	F	F	F	F	F	F	F	F	F	F	F	
	15	150	F	F	F	F	F	F	F	F	F	F	F	F	F	F	F	F	F	F	F	F	F	F	
	18	180	F	F	F	F	F	F	F	F	F	F	F	F	F	F	F	F	F	F	F	F	F	F	
	22	220	F	F	F	F	F	F	F	F	F	F	F	F	F	F	F	F	F	F	F	F	F	F	
	27	270	F	F	F	F	F	F	F	F	F	F	F	F	F	F	F	F	F	F	F	F	F	F	
	33	330	F	F	F	F	F	F	F	F	F	F	F	F	F	F	F	F	F	F	F	F	F	F	
	39	390	F	F	F	F	F	F	F	F	F	F	F	F	F	F	F	F	F	F	F	F	F	F	
	47	470	F	F	F	F	F	F	F	F	F	F	F	F	F	F	F	F	F	F	F	F	F	F	
	56	560	F	F	F	F	F	F	F	F	F	F	F	F	F	F	F	F	F	F	F	F	F	F	
	68	680	F	F	F	F	F	F	F	F	F	F	F	F	F	F	F	F	F	F	F	F	F	F	
	82	820	F	F	F	F	F	F	F	F	F	F	F	F	F	F	F	F	F	F	F	F	F	F	
	100	101	F	F	F	F	F	F	F	F	F	F	F	F	F	F	F	F	F	F	F	F	F	F	
	120	121	F	F	F	F	F	F	F	F	F	F	F	F	F	F	F	F	F	F	F	F	F	F	
	150	151	F	F	F	F	F	F	F	F	F	F	F	F	F	F	F	F	F	F	F	F	F	F	
	180	181	F	F	F	F	F	F	F	F	F	F	F	F	F	F	F	F	F	F	F	F	F	F	
	220	221	F	F	F	F	F	F	F	F	F	F	F	F	F	F	F	F	F	F	F	F	F	F	
	270	271	F	F	F	F	F	F	F	F	F	F	F	F	F	F	F	F	F	F	F	F	F	G	
	330	331	F	F	F	F	F	F	F	F	F	F	F	F	F	F	F	F	F	F	F	F	F	G	
	390	391	F	F	F	F	F	F	F	F	F	F	F	F	F	F	F	F	F	F	F	F	F		
	470	471	F	F	F	F	F	F	F	F	F	F	F	F	F	F	F	F	F	F	F	F	F		
	560	561	F	F	F	F	F	F	F	F	F	F	F	F	F	F	F	F	F	F	F	F	F		
	680	681	F	F	F	F	F	F	F	F	F	F	F	F	F	F	F	F	F	F	F	F	F		
	820	821	F	F	F	F	F	F	F	F	F	F	F	F	F	F	F	F	F	F	F	F	F		
	1000	102	F	F	F	F	F	F	F	F	F	F	F	F	F	F	F	F	F	F	F	F	F		
	1200	122	F	F	F	F	F	F	F	F	F	F		F	F	F	F	F	F	F	F	F	F	F	
	1500	152	F	F	F	F	F	F	F	F	F	F		F	F	F	F	F	F	F	F	F	F	F	
	1800	182	F	F	F	F	F	F	F	F	F	F		F	F	F	F	F	F	F	F	F	F	F	
	2200	222	F	F	F	F	F	F	F	F	F	F		F	F	F	F	F	F	F	F	F	F	F	
	2700	272	F	F	F	F	F	F	F	F	F	F		F	F	F	F	F	F	F	F	F	F	F	
	3300	332	F	F	F	F	F	F	F	F	F	F		F	F	F	F	F	F	F	F	F	F	F	
	3900	392	F	F	F	F	F	F	F	F	F	F		F	F	F	F	F	F	F	F	F	F	F	
	4700	472	F	F	F	F	F	F	F	F	F	F		F	F	F	F	F	F	F	F	F	F	F	
5600	562	F	F	F	F	F	F	F	F	F	F		F	F	F	F	F	F	F	F	F	F	F		
6800	682	F	F	F	F	F	F	F	F				F	F	F	F	F	F	F						
8200	822	F	F	F	F	F	F	F	G				F	F	F	F	F	F	G						
0.01	103	F	F	F	F	F	F	F	G				F	F	F	F	F	F	G						
0.012	123	F	F	F	F	F	F	F					F	F	F	F	F	F							
0.015	153	F	F	F	F	F	F	F					F	F	F	F	F	F							
0.018	183	F	F	F	F	F	F	F					F	F	F	F	F	F							
0.022	223	F	F	F	F	F	F	F					F	F	F	F	F	F							
0.027	273	F	F	F	F	F	F	F					F	F	F	F	F	F							
0.033	333	F	F	F	F	F	F	F					F	F	F	F	F	F	E/F						
0.039	393	F	F	E	F	F	G	G					F	F	F	F	F	F	E/F						
0.047	473	F	F	F	F	F	F						F	F	F	G	G	G	E/F						
0.056	563	F	F	F	G	G							F	F	F	G	G		F						
0.068	683	F	F	F	G	G							F	F	F	G	G		F						
0.082	823	F	F	G									F	F	G				F						
0.1	104	G	G	G									G	G	G				G						
0.12	124																								
0.15	154																								
0.18	184																								
0.22	224																								
0.27	274																								
0.33	334																								

* ARC PROTECTION COATING

CODE	E	F	G
DESCRIPTON	1.60 ± 0.20	2.00 ± 0.20	2.50 ± 0.30





CAPACITANCE RANGE

DIELECTRIC		COG											
SIZE		2225											
RATED VOLTAGE		25	50	100	200	250	500	630	1000	1500	2000	3000	4000
10	100	F	F	F	F	F	F	F	F	F	F	F	F
12	120	F	F	F	F	F	F	F	F	F	F	F	F
15	150	F	F	F	F	F	F	F	F	F	F	F	F
18	180	F	F	F	F	F	F	F	F	F	F	F	F
22	220	F	F	F	F	F	F	F	F	F	F	F	F
27	270	F	F	F	F	F	F	F	F	F	F	F	F
33	330	F	F	F	F	F	F	F	F	F	F	F	F
39	390	F	F	F	F	F	F	F	F	F	F	F	F
47	470	F	F	F	F	F	F	F	F	F	F	F	F
56	560	F	F	F	F	F	F	F	F	F	F	F	F
68	680	F	F	F	F	F	F	F	F	F	F	F	F
82	820	F	F	F	F	F	F	F	F	F	F	F	F
100	101	F	F	F	F	F	F	F	F	F	F	F	F
120	121	F	F	F	F	F	F	F	F	F	F	F	F
150	151	F	F	F	F	F	F	F	F	F	F	F	F
180	181	F	F	F	F	F	F	F	F	F	F	F	F
220	221	F	F	F	F	F	F	F	F	F	F	F	F
270	271	F	F	F	F	F	F	F	F	F	F	F	F
330	331	F	F	F	F	F	F	F	F	F	F	F	F
390	391	F	F	F	F	F	F	F	F	F	F	F	F
470	471	F	F	F	F	F	F	F	F	F	F	F	F
560	561	F	F	F	F	F	F	F	F	F	F	F	F
680	681	F	F	F	F	F	F	F	F	F	F	F	F
820	821	F	F	F	F	F	F	F	F	F	F	F	F
1000	102	F	F	F	F	F	F	F	F	F	F	F	F
1200	122	F	F	F	F	F	F	F	F	F	F	F	F
1500	152	F	F	F	F	F	F	F	F	F	F	F	F
1800	182	F	F	F	F	F	F	F	F	F	F	F	F
2200	222	F	F	F	F	F	F	F	F	F	F	F	F
2700	272	F	F	F	F	F	F	F	F	F	F	G	
3300	332	F	F	F	F	F	F	F	F	F	F	G	
3900	392	F	F	F	F	F	F	F	F	F	F	F	
4700	472	F	F	F	F	F	F	F	F	F	F	F	
5600	562	F	F	F	F	F	F	F	F	F	F	F	
6800	682	F	F	F	F	F	F	F	F	F	F	F	
8200	822	F	F	F	F	F	F	F	F	G	G		
0.01	103	F	F	F	F	F	F	F	G	G	G		
0.012	123	F	F	F	F	F	F	F					
0.015	153	F	F	F	F	F	F	F					
0.018	183	F	F	F	F	F	F	F					
0.022	223	F	F	F	F	F	F	F					
0.027	273	F	F	F	F	F	F	F					
0.033	333	F	F	F	F	F	F	F					
0.039	393	F	F	F	F	F	F	F					
0.047	473	F	F	F	F	F	F	F					
0.056	563	F	F	F	G	G	G	G					
0.068	683	F	F	F	G	G	G	G					
0.082	823	F	F	F	G	G	G						
0.1	104	F	F	G	G	G							
0.12	124												
0.15	154												
0.18	184												
0.22	224												
0.27	274												
0.33	334												

* ARC PROTECTION COATING

CODE	F	G
DESCRIPTION	2.00 ± 0.20	2.50 ± 0.30



CAPACITANCE RANGE

DIELECTRIC		X7R																									
SIZE		0402					0603					0805															
RATED VOLTAGE		6.3	10	16	25	50	100	6.3	10	16	25	35	50	100	200	250	6.3	10	16	25	50	100	200	250	500	630	1000
100pf	101		K	K	K	K	K		S	S	S	S	S	S	B	B		C	C	C	C	C	C	C	X	X	X
120pf	121		K	K	K	K	K		S	S	S	S	S	S	B	B		C	C	C	C	C	C	C	X	X	X
150pf	151		K	K	K	K	K		S	S	S	S	S	S	B	B		C	C	C	C	C	C	C	X	X	X
180pf	181		K	K	K	K	K		S	S	S	S	S	S	B	B		C	C	C	C	C	C	C	X	X	X
220pf	221		K	K	K	K	K		S	S	S	S	S	S	B	B		C	C	C	C	C	C	C	X	X	X
270pf	271		K	K	K	K	K		S	S	S	S	S	S	B	B		C	C	C	C	C	C	C	X	X	X
330pf	331		K	K	K	K	K		S	S	S	S	S	S	B	B		C	C	C	C	C	C	C	X	X	X
390	391		K	K	K	K	K		S	S	S	S	S	S	B	B		C	C	C	C	C	C	C	X	X	X
470pf	471		K	K	K	K	K		S	S	S	S	S	S	B	B		C	C	C	C	C	C	C	X	X	X
560pf	561		K	K	K	K	K		S	S	S	S	S	S	B	B		C	C	C	C	C	C	C	X	X	X
680pf	681		K	K	K	K	K		S	S	S	S	S	S	B	B		C	C	C	C	C	C	C	X	X	X
820pf	821		K	K	K	K	K		S	S	S	S	S	S	B	B		C	C	C	C	C	C	C	X	X	X
1,000pf	102		K	K	K	K	K		S	S	S	S	S	S	B	B		C	C	C	C	C	C	C	X	X	X
1,200pf	122		K	K	K	K	K		S	S	S	S	S	S	B	B		C	C	C	C	C	C	C	X	X	X
1,500pf	152		K	K	K	K	K		S	S	S	S	S	S	B	B		C	C	C	C	C	C	C	X	X	C
1,800pf	182		K	K	K	K	K		S	S	S	S	S	S	B	B		C	C	C	C	C	C	C	X	X	C
2,200pf	222		K	K	K	K	K		S	S	S	S	S	S	B	B		C	C	C	C	C	C	C	X	X	C
2,700pf	272		K	K	K	K	K		S	S	S	S	S	S	B	B		C	C	C	C	C	C	C	X	X	
3,300pf	332		K	K	K	K	K		S	S	S	S	S	S	B	B		C	C	C	C	C	C	C	X	X	
3,900pf	392		K	K	K	K	K		S	S	S	S	S	S	B	B		C	C	C	C	C	C	C	X	X	
4,700pf	472		K	K	K	K	K		S	S	S	S	S	S	B	B		C	C	C	C	C	C	C	C	C	
5,600pf	562		K	K	K	K			S	S	S	S	S	S	B	B		C	C	C	C	C	C	C	C	C	
6,800pf	682		K	K	K	K			S	S	S	S	S	S	B	B		C	C	C	C	C	C	C	C	C	
8,200pf	822		K	K	K	K			S	S	S	S	S	S	B	B		C	C	C	C	C	C	C	C	C	
10000	103		K	K	K	K			S	S	S	S	S	S	B	B		C	C	C	C	C	C	C	C	C	
12000	123		K	K	K				S	S	S	S	S	B				C	C	C	C	C	C	C	C	C	
15000	153		K	K	K				S	S	S	S	S	B				C	C	C	C	C	C	C	C	C	
18000	183		K	K	K				S	S	S	S	S	B				C	C	C	C	C	C	C	C	C	
22000	223		K	K	K				S	S	S	S	S	B				C	C	C	C	C	C	C	C	C	
27000	273		K	K	K				S	S	S	S	S	B				C	C	C	C	C	C	C	C	C	
33000	333		K	K	K				S	S	S	B	B	B				C	C	C	C	C	C	C	C		
39000	393		K	K	K				S	S	S	B	B	B				C	C	C	C	C	C	C			
47000	473		K	K	K				S	S	S	B	B	B				C	C	C	C	C	C	C			
56000	563		K	K					S	S	S	B	B	B				C	C	C	C	C	C	C			
68000	683		K	K					S	S	S	B	B	B				C	C	C	C	C	C	C			
82000	823		K	K					S	S	S	B	B	B				C	C	C	C	C	C	C			
100000	104	K	K	K					S	S	S	B	B	B				C	C	C	C	C	C				
120000	124								S	S	B							C	C	C	C	I					
150000	154								S	S	B							C	C	C	C	I					
180000	184								S	S	B							C	C	C	C	I					
220000	224								S	S	B	B	B					C	C	C	C	I					
270000	274							B	B	B	B							I	I	I	I						
330000	334								B	B	B							I	I	I	I						
390000	394								B	B	B							I	I	I	I						
470000	474							B	B	B	B							I	I	I	I	I					
560000	564								B	B								I	I	I	I						
680000	684							B	B	B								I	I	I							
820000	824								B	B								I	I	I							
1000000	105							B	B	B	B	X						I	I	I	I						
1200000	125								B	B	B	B	B														
1500000	155								B	B	B	B	B					I	I	I							
2200000	225								B	B	B	B	B					I	I	I	I						
4700000	475																	I	I	I	I						
10000000	106																	I	I								

* ARC PROTECTION COATING

CODE	B	C	K	S	X
DESCRIPTON	0.8 ± 0.15/-0.10	1.25 ± 0.10	0.50 ± 0.20	0.80 ± 0.07	0.80 ± 0.10



CAPACITANCE RANGE

CAPACITANCE RANGE	DIELECTRIC		X7R																									
	SIZE		1206												1210													
	RATED VOLTAGE		6.3	10	16	25	50	100	200	250	500	630	1000	1500	2000	6.3	10	16	25	50	100	200	250	500	630	1000	1500	2000
100pf	101							C	C	C	C	C	C	C														
120pf	121							C	C	C	C	C	C	C														
150pf	151		C	C	C	C	C	C	C	C	C	C	C	C														
180pf	181		C	C	C	C	C	C	C	C	C	C	C	C														
220pf	221		C	C	C	C	C	C	C	C	C	C	C	C					M	M	M	M	M	M	M	M	M	M
270pf	271		C	C	C	C	C	C	C	C	C	C	C	C					M	M	M	M	M	M	M	M	M	M
330pf	331		C	C	C	C	C	C	C	C	C	C	C	C					M	M	M	M	M	M	M	M	M	M
390	391		C	C	C	C	C	C	C	C	C	C	C	C					M	M	M	M	M	M	M	M	M	M
470pf	471		C	C	C	C	C	C	C	C	C	C	C	C					M	M	M	M	M	M	M	M	M	M
560pf	561		C	C	C	C	C	C	C	C	C	C	C	C					M	M	M	M	M	M	M	M	M	M
680pf	681		C	C	C	C	C	C	C	C	C	C	C	C					M	M	M	M	M	M	M	M	M	M
820pf	821		C	C	C	C	C	C	C	C	C	C	C	C					M	M	M	M	M	M	M	M	M	M
1,000pf	102		C	C	C	C	C	C	C	C	C	C	C	C	M	M	M	M	M	M	M	M	M	M	M	M	C	C
1,200pf	122		C	C	C	C	C	C	C	C	C	C	C	E	E	M	M	M	M	M	M	M	M	M	M	M	E	E
1,500pf	152		C	C	C	C	C	C	C	C	C	C	C	E	E	M	M	M	M	M	M	M	M	M	M	M	E	E
1,800pf	182		C	C	C	C	C	C	C	C	C	C	C	E	E	M	M	M	M	M	M	M	M	M	M	M	E	E
2,200pf	222		C	C	C	C	C	C	C	C	C	C	C	E	E	M	M	M	M	M	M	M	M	M	M	M	F	F
2,700pf	272		C	C	C	C	C	C	C	C	C	C	C	E	E	M	M	M	M	M	M	M	M	M	M	M	F	G
3,300pf	332		C	C	C	C	C	C	C	C	C	C	C	E	E	M	M	M	M	M	M	M	M	M	M	M	F	G
3,900pf	392		C	C	C	C	C	C	C	C	C	C	C	E		M	M	M	M	M	M	M	M	M	M	M	G	G
4,700pf	472		C	C	C	C	C	C	C	C	C	C	C	E		M	M	M	M	M	M	M	M	M	M	M	F/G	F/G
5,600pf	562		C	C	C	C	C	C	C	C	C	C	C	E		M	M	M	M	M	M	M	M	M	M	M	G	G*
6,800pf	682		C	C	C	C	C	C	C	C	C	C	C	E		M	M	M	M	M	M	M	M	M	M	M	G	G*
8,200pf	822		C	C	C	C	C	C	C	C	C	C	C	E		M	M	M	M	M	M	M	M	M	M	M	G	G*
0.01	103		C	C	C	C	C	C	C	C	C	C	C	E		M	M	M	M	M	M	M	M	M	M	C	G	G*
0.012	123		C	C	C	C	C	C	C	C	C	C	C	E		M	M	M	M	M	M	M	M	M	M	C	G	
0.015	153		C	C	C	C	C	C	C	C	C	C	C	E		M	M	M	M	M	M	M	M	M	M	E	G	
0.018	183		C	C	C	C	C	C	C	C	C	C	C			M	M	M	M	M	M	M	M	M	C	C	E	G
0.022	223		C	C	C	C	C	C	C	C	C	C	C	E		M	M	M	M	M	M	M	M	M	C	C	E	G
0.027	273		C	C	C	C	C	C	C	C	C	C	C	E		M	M	M	M	M	M	M	M	M	C	C	E	G
0.033	333		C	C	C	C	C	E	E	E	E	E	E			M	M	M	M	M	M	M	M	E	E	E	E	G
0.039	393		C	C	C	C	C	E	E	E	E	E	E			M	M	M	M	M	M	M	M	E	E	F		
0.047	473		C	C	C	C	C	E	E	E	E	E	E			M	M	M	M	M	M	M	C	C	E	E	G	
0.056	563		C	C	C	C	C	E	E	E	E	E	E			M	M	M	M	M	M	M	C	C	E	E		
0.068	683		C	C	C	C	C	E	E							M	M	M	M	M	M	M	E	E	F	F		
0.082	823		C	C	C	C	C	E	E							M	M	M	M	M	M	M	E	E	F	F		
0.1	104		C	C	C	C	C	E	E							M	M	M	M	M	M	E	E	F	F			
0.12	124		C	C	C	C	C									M	M	M	M	M	M	E	E	G	G			
0.15	154		M	M	M	M	E									M	M	M	M	M	M	C	E	E	G	G		
0.18	184		M	M	M	M	E									M	M	M	M	M	M	C	E	E				
0.22	224		M	M	M	M	E	E	E							M	M	M	M	M	M	C	E	E				
0.27	274		M	M	M	C	E									M	M	M	M	M	M	E	F	F				
0.33	334		M	M	M	C	E									M	M	M	M	M	M	C	E	F	F			
0.39	394		M	M	J	P	E									M	M	M	M	M	M	C	G	G	G			
0.47	474		J	J	J	P	E									M	M	M	M	M	M	C	G	G	G			
0.56	564		J	J	J	P	P									C	C	C	C	C	C	G	G	G				
0.68	684		J	J	J	P	P									C	C	C	C	C	C	F	G	G				
0.82	824		J	J	J	P	P									C	C	C	C	C	C	F						
1.0	105		J	J	J	P	P									C	C	C	C	C	C	F						
1.2	125					P	P	E/P																				
1.5	155		J	J	J	P	P	E/P																				
1.8	185					P	P	P																				
2.2	225		J	J	J	E/P	P	P																				
2.7	275					P	P																					
3.3	335			P	P	P	P																					
3.9	395					P	P																					
4.7	475		P	P	P	P	P																					
10	106		P	P	P	P																						
22	226			P																								
47	476																											

* ARC PROTECTION COATING

CODE	C	E	F	G	J	M	P
DESCRIPTION	1.25 ± 0.10	1.60 ± 0.20	2.00 ± 0.20	2.50 ± 0.30	1.15 ± 0.15	0.95 ± 0.10	1.60 +0.3/-0.10





CAPACITANCE RANGE

CAPACITANCE RANGE	DIELECTRIC		X7R																					
	SIZE		1808							1812														
	RATED VOLTAGE		500	630	1000	1500	2000	3000	4000	10	16	25	50	100	200	250	400	500	630	1000	1500	2000	3000	4000
150pf	151	C	C	C	C	C	C	F*																
180pf	181	C	C	C	C	C	C	F*																
220pf	221	C	C	C	C	C	C	F*																
270pf	271	C	C	C	C	C	C	F*	C	C	C	C	C	C	C	C	C	C	C	C	C	C	C	F*
330pf	331	C	C	C	C	C	C	F*	C	C	C	C	C	C	C	C	C	C	C	C	C	C	C	F*
390	391	C	C	C	C	C	C	F*	C	C	C	C	C	C	C	C	C	C	C	C	C	C	C	F*
470pf	471	C	C	C	C	C	C	F*	C	C	C	C	C	C	C	C	C	C	C	C	C	C	C	F*
560pf	561	C	C	C	C	C	E	F*	C	C	C	C	C	C	C	C	C	C	C	C	C	C	C	F*
680pf	681	C	C	C	C	C	E	F*	C	C	C	C	C	C	C	C	C	C	C	C	C	C	C	F*
820pf	821	C	C	C	C	C	E	F*	C	C	C	C	C	C	C	C	C	C	C	C	C	C	C	F*
1,000pf	102	C	C	C	C	C	F	F*	C	C	C	C	C	C	C	C	C	C	C	C	C	C	E	F*
1,200pf	122	C	C	C	C	C	F		C	C	C	C	C	C	C	C	C	C	C	C	C	C	F	G*
1,500pf	152	C	C	C	C	C	F		C	C	C	C	C	C	C	C	C	C	C	C	C	C	F	G*
1,800pf	182	C	C	C	C	C	F		C	C	C	C	C	C	C	C	C	C	C	C	C	C	G	G*
2,200pf	222	C	C	C	E	E	F		C	C	C	C	C	C	C	C	C	C	C	C	C	C	G*	
2,700pf	272	C	C	C	F	F	F		C	C	C	C	C	C	C	C	C	C	C	C	C	C	G*	
3,300pf	332	C	C	C	F	F	F		C	C	C	C	C	C	C	C	C	C	C	C	E	E	G*	
3,900pf	392	C	C	C	F	F	F*		C	C	C	C	C	C	C	C	C	C	C	C	F	F	G*	
4,700pf	472	C	C	C	F	F	F*		C	C	C	C	C	C	C	C	C	C	C	C	F	F	G*	
5,600pf	562	C	C	C	F	F	F*		C	C	C	C	C	C	C	C	C	C	C	C	G	G		
6,800pf	682	C	C	C	F	F	F*		C	C	C	C	C	C	C	C	C	C	C	C	G	G		
8,200pf	822	C	C	C	F*	F*	F*		C	C	C	C	C	C	C	C	C	C	C	C	G	G		
0.01	103	C	C	C	F*	F*	F*		C	C	C	C	C	C	C	C	C	C	C	C	E/F/G	E/F/G		
0.012	123	E	E	E					C	C	C	C	C	C	C	C	C	C	C	C	E/F/G			
0.015	153	E	E	E					C	C	C	C	C	C	C	C	C	C	C	C	E/F/G			
0.018	183	F	F	F					C	C	C	C	C	C	C	C	C	C	C	C	E	E/F/G		
0.022	223	F	F	F					C	C	C	C	C	C	C	C	C	C	C	C	E	F/G		
0.027	273	F	F	F					C	C	C	C	C	C	C	C	C	C	C	C	F			
0.033	333	F	F	F					C	C	C	C	C	C	C	C	C	C	C	C	F			
0.039	393	F	F	F					C	C	C	C	C	C	C	C	C	C	C	C	F			
0.047	473	F	F	F					C	C	C	C	C	C	C	C	C	C	C	C	F/G			
0.056	563	F	F	F					C	C	C	C	C	C	C	C	E	E	G					
0.068	683	F	F						C	C	C	C	C	C	C	C	E	E	G					
0.082	823	F	F						C	C	C	C	C	C	C	C	E	E	G					
0.1	104								C	C	C	C	C	C	C	C	E	E	G					
0.12	124								C	C	C	C	C	C	C	C	F	F						
0.15	154								C	C	C	C	C	C	C	C	F	F						
0.18	184								C	C	C	C	C	C	C	C	G	G						
0.22	224								C	C	C	C	C	C	C	C	G	G						
0.27	274								C	C	C	C	C	E	E	E	G							
0.33	334								C	C	C	C	C	E	E	E	G							
0.39	394								C	C	C	C	C	F	F	F	G							
0.47	474								C	C	C	C	C	F	F	F	G							
0.56	564								C	C	C	C	C	G	G									
0.68	684								C	C	C	C	C	G	G									
0.82	824								C	C	C	C	C	G	G									
1.0	105								C	C	C	C	C	G	G									
1.2	125								C	C	C	C	C											
1.5	155								C	C	C	C	C											
1.8	185								E	E	E	E	E											
2.2	225								E	E	E	E	E											
2.7	275								F	F	F	F	F											
3.3	335								F	F	F	F	F											
3.9	395								F	F	F	F	F											
4.7	475								G	G	G	G	G											
5.6	565								G	G	G	G												
6.8	685								G	G	G	G												
8.2	825								G	G	G	G												
10	106								G	G	G	G												
12	126								G	G	G													
15	156								G	G	G													
18	186								GG	GG	GG													

* ARC PROTECTION COATING

CODE	C	E	F	G
DESCRIPTION	1.25 ± 0.10	1.60 ± 0.20	2.00 ± 0.20	2.50 ± 0.30



CAPACITANCE RANGE

DIELECTRIC	SIZE	RATED VOLTAGE	X7R																																	
			1825												2220																					
			25	50	100	200	250	500	630	1000	1500	2000	3000	4000	25	50	100	200	250	400	500	630	1000	1500	2000	3000	4000									
220pf	221																																			
270pf	271												F*																						F*	
330pf	331												F*																							F*
390	391												F*																							F*
470pf	471												F*																							F*
560pf	561												F*																							F*
680pf	681												F*																							F*
820pf	821												F*																							F*
1,000pf	102	F	F	F	F	F	F	F	F	F	F	F	F*	F	F	F	F	F	F	F	F	F	F	F	F	F	F	F	F	F	F	F	F	F	F*	
1,200pf	122	F	F	F	F	F	F	F	F	F	F	F	G*	F	F	F	F	F	F	F	F	F	F	F	F	F	F	F	F	F	F	F	F	F	G*	
1,500pf	152	F	F	F	F	F	F	F	F	F	F	F	G*	F	F	F	F	F	F	F	F	F	F	F	F	F	F	F	F	F	F	F	F	F	G*	
1,800pf	182	F	F	F	F	F	F	F	F	F	F	F	G*	F	F	F	F	F	F	F	F	F	F	F	F	F	F	F	F	F	F	F	F	F	G*	
2,200pf	222	F	F	F	F	F	F	F	F	F	F	F	F	F	F	F	F	F	F	F	F	F	F	F	F	F	F	F	F	F	F	F	F	F	F*	
2,700pf	272	F	F	F	F	F	F	F	F	F	F	F	F*	F	F	F	F	F	F	F	F	F	F	F	F	F	F	F	F	F	F	F	F	F	F*	
3,300pf	332	F	F	F	F	F	F	F	F	F	F	F	F*	F	F	F	F	F	F	F	F	F	F	F	F	F	F	F	F	F	F	F	F	F	F*	
3,900pf	392	F	F	F	F	F	F	F	F	F	F	F	F*	F	F	F	F	F	F	F	F	F	F	F	F	F	F	F	F	F	F	F	F	F	F*	
4,700pf	472	F	F	F	F	F	F	F	F	F	F	F	F*	F	F	F	F	F	F	F	F	F	F	F	F	F	F	F	F	F	F	F	F	F	F*	
5,600pf	562	F	F	F	F	F	F	F	F	F	F	F	G*	F	F	F	F	F	F	F	F	F	F	F	F	F	F	F	F	F	F	F	F	F	F*	
6,800pf	682	F	F	F	F	F	F	F	F	F	F	F	G*	F	F	F	F	F	F	F	F	F	F	F	F	F	F	F	F	F	F	F	F	F	G*	
8,200pf	822	F	F	F	F	F	F	F	F	F	F	F	G*	F	F	F	F	F	F	F	F	F	F	F	F	F	F	G	G	G	G	G	G	G	G*	
0.01	103	F	F	F	F	F	F	F	F	F	F	F	G*	F	F	F	F	F	F	F	F	F	F	F	F	F	F	G	G	F/G	F/G	F/G	G*	G*		
0.012	123	F	F	F	F	F	F	F	F	G	G	H*	F	F	F	F	F	F	F	F	F	F	F	F	F	F	F	G	G	G	G	H*	H*	H*		
0.015	153	F	F	F	F	F	F	F	F	G	G	H*	F	F	F	F	F	F	F	F	F	F	F	F	F	F	F	G	G	G	G	H*	H*	H*		
0.018	183	F	F	F	F	F	F	F	F	G	G	H*	F	F	F	F	F	F	F	F	F	F	F	F	F	F	F	G	H	H	H	H*	H*	H*		
0.022	223	F	F	F	F	F	F	F	F	G	G	F	F	F	F	F	F	F	F	F	F	F	F	F	F	F	F	F	F	F	F	F	F	F	F	
0.027	273	F	F	F	F	F	F	F	F	H	H		F	F	F	F	F	F	F	F	F	F	F	F	F	F	F	F	F	F	F	F	F	F	F	
0.033	333	F	F	F	F	F	F	F	F	H	H		F	F	F	F	F	F	F	F	F	F	F	F	F	F	F	F	F	F	F	F	F	F	F	
0.039	393	F	F	F	F	F	F	F	F	H	H		F	F	F	F	F	F	F	F	F	F	F	F	F	F	F	F	F	F	F	F	F	F	F	F
0.047	473	F	F	F	F	F	F	F	F	H	H		F	F	F	F	F	F	F	F	F	F	F	F	F	F	F	F	F	F	F	F	F	F	F	F
0.056	563	F	F	F	F	F	F	F	F	H			F	F	F	F	F	F	F	F	F	F	F	F	F	F	F	F	F	F	F	F	F	F	F	F
0.068	683	F	F	F	F	F	F	F	F				F	F	F	F	F	F	F	F	F	F	F	F	F	F	F	F	F	F	F	F	F	F	F	F
0.082	823	F	F	F	F	F	F	F	F				F	F	F	F	F	F	F	F	F	F	F	F	F	F	F	F	F	F	F	F	F	F	F	F
0.1	104	F	F	F	F	F	F	F	G				F	F	F	F	F	F	F	F	F	F	F	F	F	F	F	G	F	F	F	F	F	F	F	
0.12	124	F	F	F	F	F	F	F					F	F	F	F	F	F	F	F	F	F	F	F	F	F	F	F	F	F	F	F	F	F	F	F
0.15	154	F	F	F	F	F	F	F					F	F	F	F	F	F	F	F	F	F	F	F	F	F	F	F	F	F	F	F	F	F	F	F
0.18	184	F	F	F	F	F	F	F					F	F	F	F	F	F	F	F	F	F	F	F	F	F	F	F	F	F	F	F	F	F	F	F
0.22	224	F	F	F	F	F	F	F					F	F	F	F	F	F	F	F	F	F	F	F	F	F	F	F	F	F	F	F	F	F	F	F
0.27	274	F	F	F	F	F	F	F					F	F	F	F	F	F	F	F	F	F	F	F	F	F	F	F	F	F	F	F	F	F	F	F
0.33	334	F	F	F	F	F	F	F					F	F	F	F	F	F	F	F	F	F	F	F	F	F	F	F	F	F	F	F	F	F	F	F
0.39	394	F	F	F	F	F	F	F					F	F	F	F	F	F	F	F	F	F	F	F	F	F	F	F	F	F	F	F	F	F	F	F
0.47	474	F	F	F	F	F	F	F					F	F	F	F	F	F	F	F	F	F	F	F	F	F	F	F	F	F	F	F	F	F	F	F
0.56	564	F	F	F	F	F	F	G	G				F	F	F	F	F	F	F	G	G	G	G	G	G	G	G	G	G	G	G	G	G	G	G	G
0.68	684	F	F	F	F	F	F						F	F	F	F	F	F	F	G	G	G	G	G	G	G	G	G	G	G	G	G	G	G	G	G
0.82	824	F	F	F	F	F							F	F	F	F	F	F	H	H	H	H	H	H	H	H	H	H	H	H	H	H	H	H	H	H
1	105	F	F	F	F	F							F	F	F	F	F	H	H	H	H	H	H	H	H	H	H	H	H	H	H	H	H	H	H	H
1.2	125	F	F	F	G								F	F	F	G	G																			
1.5	155	F	F	F	G								F	F	F	G	G																			
1.8	185	F	F	F	G								F	F	F	G	G																			
2.2	225	F	F	F	G								F	F	F	G	G																			
2.7	275	F	F	F									F	F	F																					
3.3	335	F	F	F									F	F	F																					
3.9	395	F	F	F									F	F	F																					
4.7	475	F	F	F									F	F	F																					
5.6	565	F	F	F									F	F	F																					
6.8	685	F	F	F									F	F	F																					
8.2	825	G	G	G									G	G	G																					
10	106	G	G	G									G	G	G																					
12	126												H	H																						
15	156												H	H																						
18	186												H	H																						
22	226												H	H																						
27	276												H	H																						
33	336												H	H																						
39	396												H	H																						
47	476												R	R																						

CODE	F	G	H	R
DESCRIPTION	2.00 ± 0.20	2.50 ± 0.30	2.80 ± 0.30	3.10 ± 0.30



CAPACITANCE RANGE

DIELECTRIC		X7R													
SIZE		2225													
RATED VOLTAGE		25	50	100	200	250	500	630	1000	1500	2000	3000	4000	5000	
220pf	221														
270pf	271												F*	F*	
330pf	331												F*	F*	
390	391												F*	F*	
470pf	471												F*	F*	
560pf	561												F*	F*	
680pf	681												F*	F*	
820pf	821												F*	F*	
1,000pf	102	F	F	F	F	F	F	F	F	F	F	F*	F*	F*	
1,200pf	122	F	F	F	F	F	F	F	F	F	F	F*	G*	F*	
1,500pf	152	F	F	F	F	F	F	F	F	F	F	F*	G*	F*	
1,800pf	182	F	F	F	F	F	F	F	F	F	F	F*	G*	F*	
2,200pf	222	F	F	F	F	F	F	F	F	F	F	F*		F*	
2,700pf	272	F	F	F	F	F	F	F	F	F	F	F*		F*	
3,300pf	332	F	F	F	F	F	F	F	F	F	F	F*		F*	
3,900pf	392	F	F	F	F	F	F	F	F	F	F	F*		F*	
4,700pf	472	F	F	F	F	F	F	F	F	F	F	F*		F/G*	
5,600pf	562	F	F	F	F	F	F	F	F	F	F	G*			
6,800pf	682	F	F	F	F	F	F	F	F	F	F	G*			
8,200pf	822	F	F	F	F	F	F	F	F	F	F	G*			
0.01	103	F	F	F	F	F	F	F	F	F	F	F	G*		
0.012	123	F	F	F	F	F	F	F	F	G	G	G*			
0.015	153	F	F	F	F	F	F	F	F	G	G	G*			
0.018	183	F	F	F	F	F	F	F	F	G	G	H*			
0.022	223	F	F	F	F	F	F	F	F	F/G	F/G				
0.027	273	F	F	F	F	F	F	F	F	G	G				
0.033	333	F	F	F	F	F	F	F	F	G	G				
0.039	393	F	F	F	F	F	F	F	F	G	H				
0.047	473	F	F	F	F	F	F	F	F	G	H				
0.056	563	F	F	F	F	F	F	F	F	G	H				
0.068	683	F	F	F	F	F	F	F	F	G					
0.082	823	F	F	F	F	F	F	F	F	G					
0.1	104	F	F	F	F	F	F	F	F	G	G				
0.12	124	F	F	F	F	F	F	F	H						
0.15	154	F	F	F	F	F	F	F	H						
0.18	184	F	F	F	F	F	F	F	H						
0.22	224	F	F	F	F	F	F	F	H						
0.27	274	F	F	F	F	F	F	F	F/G/H						
0.33	334	F	F	F	F	F	F	F	F/G/H						
0.39	394	F	F	F	F	F	F	F							
0.47	474	F	F	F	F	F	F	F							
0.56	564	F	F	F	F	F	F	F							
0.68	684	F	F	F	F	F									
0.82	824	F	F	F	F	F									
1	105	F	F	F	F	F									
1.2	125	F	F	F	G	G									
1.5	155	F	F	F	G	G									
1.8	185	F	F	F	G	G									
2.2	225	F	F	F	G	G									
2.7	275	F	F	F	G	G									
3.3	335	F	F	F											
3.9	395	F	F	F											
4.7	475	F	F	F											
5.6	565	F	F	F											
6.8	685	F	F	F											
8.2	825	G	G	G											
10	106	G	G	G											
12	126	F/G													
15	156	F/G													

* ARC PROTECTION COATING

CODE	F	G	H
DESCRIPTION	2.00 ± 0.20	2.50 ± 0.30	2.80 ± 0.30



RELIABILITY TEST CONDITIONS AND REQUIREMENTS

NO.	ITEM	TEST CONDITION	REQUIREMENTS																																																																								
1.	Visual and Mechanical	---	- No remarkable damage. - Dimensions to conform to individual specification sheet.																																																																								
2.	Capacitance	- Class I : Cap. ≤1000pF, 1.0±0.2Vrms, 1MHz±10%. Cap. >1000pF, 1.0±0.2Vrms, 1KHz±10%. - Class II : Cap. ≤10μF, 1.0±0.2Vrms, 1KHz±10%**. Cap. >10μF, 0.5±0.2Vrms, 120Hz±20%. ** Test condition: 0.5±0.2Vrms, 1KHz±10% - X7R: 0805 - 106 (6.3V), 0603/475 (6.3V)	- Shall not exceed the limits given in the detailed spec. - Class I : <table border="1"> <thead> <tr> <th>DIELECTRIC</th> <th>RATED VOL.</th> <th>Q/D. F</th> <th>REMARK</th> </tr> </thead> <tbody> <tr> <td>Class 1</td> <td>All</td> <td>Q₂≥1000</td> <td>Cap. ≥30pF</td> </tr> <tr> <td></td> <td></td> <td>Q₂≥400+20C</td> <td>Cap. <30pF</td> </tr> </tbody> </table> - Class II: <table border="1"> <thead> <tr> <th>RATED</th> <th>D.F. ≤</th> <th colspan="2">EXCEPTION OF D.F. ≤</th> </tr> </thead> <tbody> <tr> <td rowspan="3">≥100V</td> <td rowspan="3">≤2.5%</td> <td>≤3.5%</td> <td>0603≥0.047μF, 0805=0.1μF, 1206≥0.47μF, 1812≥4.7μF, 1825≥4.7μF, 2220≥4.7μF, 2225≥4.7μF</td> </tr> <tr> <td>≤5%</td> <td>0603≥0.068μF, 0805>0.1μF, 1206>1μF, 1210≥2.2μF</td> </tr> <tr> <td>≤10%</td> <td>0805>0.22μF, 1210≥3.3μF</td> </tr> <tr> <td rowspan="3">50V</td> <td rowspan="3">≤2.5%</td> <td>≤3.5%</td> <td>0403≥0.047μF, 0805≥0.1μF, 1206≥0.47μF, 1210≥2.2μF, 1812≥4.7μF, 1825≥4.7μF, 2220≥4.7μF, 2225≥4.7μF</td> </tr> <tr> <td>≤5%</td> <td>1210≥4.7μF</td> </tr> <tr> <td>≤10%</td> <td>0402≥0.1μF, 0603>0.1μF, 0805≥1μF, 1206≥2.2μF, 1210≥10μF</td> </tr> <tr> <td rowspan="3">35V</td> <td rowspan="3">≤3.5%</td> <td>≤10%</td> <td>0603≥1μF, 0805≥2.2μF, 1206≥2.2μF, 1210≥10μF</td> </tr> <tr> <td>≤5%</td> <td>0805≥1μF, 1210≥10μF</td> </tr> <tr> <td>≤7%</td> <td>0603≥0.33μF, 1206≥4.7μF</td> </tr> <tr> <td rowspan="3">25V</td> <td rowspan="3">≤3.5%</td> <td>≤10%</td> <td>0402≥0.10μF, 0603≥0.47μF, 0805≥2.2μF, 1206≥6.8μF, 1210≥22μF</td> </tr> <tr> <td>≤12.5%</td> <td>0402≥0.47μF</td> </tr> <tr> <td>≤5%</td> <td>0402≥0.033μF, 0603≥0.15μF, 0805≥0.68μF, 1206≥2.2μF, 1210≥4.7μF</td> </tr> <tr> <td rowspan="3">16V</td> <td rowspan="3">≤3.5%</td> <td>≤10%</td> <td>0402≥0.22μF, 0603≥0.68μF, 0805≥2.2μF, 1206≥4.7μF, 1210≥22μF</td> </tr> <tr> <td>≤15%</td> <td>0402≥0.33μF, 0603≥0.22μF, 0603≥0.33μF, 0805≥2.2μF, 1206≥2.2μF, 1210≥22μF</td> </tr> <tr> <td>≤15%</td> <td>0402≥1μF</td> </tr> <tr> <td rowspan="3">10V</td> <td rowspan="3">≤5%</td> <td>≤10%</td> <td>0402≥1μF, 0603≥10μF, 0805≥4.7μF, 1206≥47μF, 1210≥100μF</td> </tr> <tr> <td>≤15%</td> <td>0402≥1μF, 0603≥10μF, 0805≥4.7μF, 1206≥47μF, 1210≥100μF</td> </tr> <tr> <td>≤20%</td> <td>0402≥2.2μF</td> </tr> <tr> <td rowspan="3">6.3V</td> <td rowspan="3">≤10%</td> <td>---</td> <td>---</td> </tr> <tr> <td>---</td> <td>---</td> </tr> <tr> <td>---</td> <td>---</td> </tr> </tbody> </table> *Before initial measurement (Class II only) : To apply deaging at 150°C for 1hr then set for 24±2 hrs at room temp	DIELECTRIC	RATED VOL.	Q/D. F	REMARK	Class 1	All	Q ₂ ≥1000	Cap. ≥30pF			Q ₂ ≥400+20C	Cap. <30pF	RATED	D.F. ≤	EXCEPTION OF D.F. ≤		≥100V	≤2.5%	≤3.5%	0603≥0.047μF, 0805=0.1μF, 1206≥0.47μF, 1812≥4.7μF, 1825≥4.7μF, 2220≥4.7μF, 2225≥4.7μF	≤5%	0603≥0.068μF, 0805>0.1μF, 1206>1μF, 1210≥2.2μF	≤10%	0805>0.22μF, 1210≥3.3μF	50V	≤2.5%	≤3.5%	0403≥0.047μF, 0805≥0.1μF, 1206≥0.47μF, 1210≥2.2μF, 1812≥4.7μF, 1825≥4.7μF, 2220≥4.7μF, 2225≥4.7μF	≤5%	1210≥4.7μF	≤10%	0402≥0.1μF, 0603>0.1μF, 0805≥1μF, 1206≥2.2μF, 1210≥10μF	35V	≤3.5%	≤10%	0603≥1μF, 0805≥2.2μF, 1206≥2.2μF, 1210≥10μF	≤5%	0805≥1μF, 1210≥10μF	≤7%	0603≥0.33μF, 1206≥4.7μF	25V	≤3.5%	≤10%	0402≥0.10μF, 0603≥0.47μF, 0805≥2.2μF, 1206≥6.8μF, 1210≥22μF	≤12.5%	0402≥0.47μF	≤5%	0402≥0.033μF, 0603≥0.15μF, 0805≥0.68μF, 1206≥2.2μF, 1210≥4.7μF	16V	≤3.5%	≤10%	0402≥0.22μF, 0603≥0.68μF, 0805≥2.2μF, 1206≥4.7μF, 1210≥22μF	≤15%	0402≥0.33μF, 0603≥0.22μF, 0603≥0.33μF, 0805≥2.2μF, 1206≥2.2μF, 1210≥22μF	≤15%	0402≥1μF	10V	≤5%	≤10%	0402≥1μF, 0603≥10μF, 0805≥4.7μF, 1206≥47μF, 1210≥100μF	≤15%	0402≥1μF, 0603≥10μF, 0805≥4.7μF, 1206≥47μF, 1210≥100μF	≤20%	0402≥2.2μF	6.3V	≤10%	---	---	---	---	---	---
DIELECTRIC	RATED VOL.	Q/D. F	REMARK																																																																								
Class 1	All	Q ₂ ≥1000	Cap. ≥30pF																																																																								
		Q ₂ ≥400+20C	Cap. <30pF																																																																								
RATED	D.F. ≤	EXCEPTION OF D.F. ≤																																																																									
≥100V	≤2.5%	≤3.5%	0603≥0.047μF, 0805=0.1μF, 1206≥0.47μF, 1812≥4.7μF, 1825≥4.7μF, 2220≥4.7μF, 2225≥4.7μF																																																																								
		≤5%	0603≥0.068μF, 0805>0.1μF, 1206>1μF, 1210≥2.2μF																																																																								
		≤10%	0805>0.22μF, 1210≥3.3μF																																																																								
50V	≤2.5%	≤3.5%	0403≥0.047μF, 0805≥0.1μF, 1206≥0.47μF, 1210≥2.2μF, 1812≥4.7μF, 1825≥4.7μF, 2220≥4.7μF, 2225≥4.7μF																																																																								
		≤5%	1210≥4.7μF																																																																								
		≤10%	0402≥0.1μF, 0603>0.1μF, 0805≥1μF, 1206≥2.2μF, 1210≥10μF																																																																								
35V	≤3.5%	≤10%	0603≥1μF, 0805≥2.2μF, 1206≥2.2μF, 1210≥10μF																																																																								
		≤5%	0805≥1μF, 1210≥10μF																																																																								
		≤7%	0603≥0.33μF, 1206≥4.7μF																																																																								
25V	≤3.5%	≤10%	0402≥0.10μF, 0603≥0.47μF, 0805≥2.2μF, 1206≥6.8μF, 1210≥22μF																																																																								
		≤12.5%	0402≥0.47μF																																																																								
		≤5%	0402≥0.033μF, 0603≥0.15μF, 0805≥0.68μF, 1206≥2.2μF, 1210≥4.7μF																																																																								
16V	≤3.5%	≤10%	0402≥0.22μF, 0603≥0.68μF, 0805≥2.2μF, 1206≥4.7μF, 1210≥22μF																																																																								
		≤15%	0402≥0.33μF, 0603≥0.22μF, 0603≥0.33μF, 0805≥2.2μF, 1206≥2.2μF, 1210≥22μF																																																																								
		≤15%	0402≥1μF																																																																								
10V	≤5%	≤10%	0402≥1μF, 0603≥10μF, 0805≥4.7μF, 1206≥47μF, 1210≥100μF																																																																								
		≤15%	0402≥1μF, 0603≥10μF, 0805≥4.7μF, 1206≥47μF, 1210≥100μF																																																																								
		≤20%	0402≥2.2μF																																																																								
6.3V	≤10%	---	---																																																																								
		---	---																																																																								
		---	---																																																																								
3.	Q/D.F (Dissipation Factor)																																																																										
4.	Temperature Coefficient	- With no electrical load. <table border="1"> <thead> <tr> <th>T.C.</th> <th>OPERATING TEMPERATURE</th> </tr> </thead> <tbody> <tr> <td>COG</td> <td>-55~125°C at 25°C</td> </tr> <tr> <td>X7R</td> <td>-55~125°C at 25°C</td> </tr> </tbody> </table> - Measurement voltage for Class II: <table border="1"> <thead> <tr> <th>SIZE</th> <th>CAP. RANGE</th> <th>CONDITION</th> </tr> </thead> <tbody> <tr> <td rowspan="4">0402</td> <td>Cap. <0.1μF</td> <td>1V</td> </tr> <tr> <td>Cap. = 1μF</td> <td>0.5V</td> </tr> <tr> <td>1μF < Cap. < 10μF</td> <td>0.2V</td> </tr> <tr> <td>Cap. ≥ 10μF</td> <td>0.1V</td> </tr> <tr> <td rowspan="3">0603</td> <td>Cap. ≤ 1μF</td> <td>1V</td> </tr> <tr> <td>1μF < Cap. ≤ 4.7μF</td> <td>0.5V</td> </tr> <tr> <td>Cap. > 4.7μF</td> <td>0.2V</td> </tr> <tr> <td rowspan="3">0805</td> <td>Cap. < 10μF</td> <td>1V</td> </tr> <tr> <td>Cap. = 10μF</td> <td>0.5V</td> </tr> <tr> <td>Cap. > 10μF</td> <td>0.2V</td> </tr> <tr> <td rowspan="3">1206/1210</td> <td>Cap. ≤ 10μF</td> <td>1V</td> </tr> <tr> <td>10μF < Cap. ≤ 100μF</td> <td>0.5V</td> </tr> <tr> <td>Cap. > 100μF</td> <td>0.2V</td> </tr> </tbody> </table>	T.C.	OPERATING TEMPERATURE	COG	-55~125°C at 25°C	X7R	-55~125°C at 25°C	SIZE	CAP. RANGE	CONDITION	0402	Cap. <0.1μF	1V	Cap. = 1μF	0.5V	1μF < Cap. < 10μF	0.2V	Cap. ≥ 10μF	0.1V	0603	Cap. ≤ 1μF	1V	1μF < Cap. ≤ 4.7μF	0.5V	Cap. > 4.7μF	0.2V	0805	Cap. < 10μF	1V	Cap. = 10μF	0.5V	Cap. > 10μF	0.2V	1206/1210	Cap. ≤ 10μF	1V	10μF < Cap. ≤ 100μF	0.5V	Cap. > 100μF	0.2V	-No evidence of damage or flash over during test. <table border="1"> <thead> <tr> <th>T.C.</th> <th>CAPACITANCE CHANGE</th> </tr> </thead> <tbody> <tr> <td>COG</td> <td>Within ±30ppm/°C</td> </tr> <tr> <td>X7R</td> <td>Within ±15%</td> </tr> </tbody> </table>	T.C.	CAPACITANCE CHANGE	COG	Within ±30ppm/°C	X7R	Within ±15%																											
T.C.	OPERATING TEMPERATURE																																																																										
COG	-55~125°C at 25°C																																																																										
X7R	-55~125°C at 25°C																																																																										
SIZE	CAP. RANGE	CONDITION																																																																									
0402	Cap. <0.1μF	1V																																																																									
	Cap. = 1μF	0.5V																																																																									
	1μF < Cap. < 10μF	0.2V																																																																									
	Cap. ≥ 10μF	0.1V																																																																									
0603	Cap. ≤ 1μF	1V																																																																									
	1μF < Cap. ≤ 4.7μF	0.5V																																																																									
	Cap. > 4.7μF	0.2V																																																																									
0805	Cap. < 10μF	1V																																																																									
	Cap. = 10μF	0.5V																																																																									
	Cap. > 10μF	0.2V																																																																									
1206/1210	Cap. ≤ 10μF	1V																																																																									
	10μF < Cap. ≤ 100μF	0.5V																																																																									
	Cap. > 100μF	0.2V																																																																									
T.C.	CAPACITANCE CHANGE																																																																										
COG	Within ±30ppm/°C																																																																										
X7R	Within ±15%																																																																										
5.	Insulation Resistance		-No evidence of damage or flash over during test. <table border="1"> <thead> <tr> <th>DIELECTRIC</th> <th>CAPACITANCE RANGE</th> </tr> </thead> <tbody> <tr> <td>Class I</td> <td>≥10GΩ or RxC≥500Ω-F, whichever is smaller</td> </tr> <tr> <td>Class II</td> <td>≥10GΩ or RxC≥100Ω-F, whichever is smaller</td> </tr> </tbody> </table> - Except (Class II) <table border="1"> <thead> <tr> <th>RATED VOLTAGE (X7R)</th> <th>I.R.</th> </tr> </thead> <tbody> <tr> <td>≥10GΩ or RxC≥100Ω-F, whichever is smaller</td> <td rowspan="10">≥10GΩ or RxC≥100Ω-F, whichever is smaller</td> </tr> <tr> <td>50V : 0402=0.01μF, 0603=1μF, 0805=1μF, 1206=4.7μF, 1210=4.7μF, 1812=10μF, 2220=22μF</td> </tr> <tr> <td>35V : 0805=2.2μF, 1206=2.2μF, 1210=10μF</td> </tr> <tr> <td>25V : 0402=1μF, 0603=2.2μF, 0805=2.2μF, 1206=10μF, 1210=10μF</td> </tr> <tr> <td>16V : 0402=0.22μF, 0603=1μF, 0805=2.2μF, 1206=10μF, 1210=47μF</td> </tr> <tr> <td>10V : 0402=0.47μF, 0603=0.47μF, 0805=2.2μF, 1206=4.7μF, 1210=47μF</td> </tr> <tr> <td>6.3V, 4V</td> </tr> <tr> <th>RATED VOLTAGE (X7R)</th> <th>I.R.</th> </tr> <tr> <td>100V : 1210=3.3μF</td> <td rowspan="8">RxC≥50Ω-F</td> </tr> <tr> <td>50V : 0402=1μF, 0603=2.2μF, 0805=10μF, 1206=10μF</td> </tr> <tr> <td>35V : 0603=1μF</td> </tr> <tr> <td>25V : 0402=2.2μF, 0603=10μF, 0805=10μF, 1206=22μF</td> </tr> <tr> <td>16V : 0603=10μF, 0402=1μF, 0201=0.22μF</td> </tr> <tr> <td>10V : 0402=1μF, 0603=10μF, 0805=47μF</td> </tr> <tr> <td>6.3V : 0603=4.7μF, 0805=47μF, 1206=10μF</td> </tr> <tr> <td>4V : 0603=22μF, 0805=47μF, 1206=100μF</td> </tr> </tbody> </table>	DIELECTRIC	CAPACITANCE RANGE	Class I	≥10GΩ or RxC≥500Ω-F, whichever is smaller	Class II	≥10GΩ or RxC≥100Ω-F, whichever is smaller	RATED VOLTAGE (X7R)	I.R.	≥10GΩ or RxC≥100Ω-F, whichever is smaller	≥10GΩ or RxC≥100Ω-F, whichever is smaller	50V : 0402=0.01μF, 0603=1μF, 0805=1μF, 1206=4.7μF, 1210=4.7μF, 1812=10μF, 2220=22μF	35V : 0805=2.2μF, 1206=2.2μF, 1210=10μF	25V : 0402=1μF, 0603=2.2μF, 0805=2.2μF, 1206=10μF, 1210=10μF	16V : 0402=0.22μF, 0603=1μF, 0805=2.2μF, 1206=10μF, 1210=47μF	10V : 0402=0.47μF, 0603=0.47μF, 0805=2.2μF, 1206=4.7μF, 1210=47μF	6.3V, 4V	RATED VOLTAGE (X7R)	I.R.	100V : 1210=3.3μF	RxC≥50Ω-F	50V : 0402=1μF, 0603=2.2μF, 0805=10μF, 1206=10μF	35V : 0603=1μF	25V : 0402=2.2μF, 0603=10μF, 0805=10μF, 1206=22μF	16V : 0603=10μF, 0402=1μF, 0201=0.22μF	10V : 0402=1μF, 0603=10μF, 0805=47μF	6.3V : 0603=4.7μF, 0805=47μF, 1206=10μF	4V : 0603=22μF, 0805=47μF, 1206=100μF																																													
DIELECTRIC	CAPACITANCE RANGE																																																																										
Class I	≥10GΩ or RxC≥500Ω-F, whichever is smaller																																																																										
Class II	≥10GΩ or RxC≥100Ω-F, whichever is smaller																																																																										
RATED VOLTAGE (X7R)	I.R.																																																																										
≥10GΩ or RxC≥100Ω-F, whichever is smaller	≥10GΩ or RxC≥100Ω-F, whichever is smaller																																																																										
50V : 0402=0.01μF, 0603=1μF, 0805=1μF, 1206=4.7μF, 1210=4.7μF, 1812=10μF, 2220=22μF																																																																											
35V : 0805=2.2μF, 1206=2.2μF, 1210=10μF																																																																											
25V : 0402=1μF, 0603=2.2μF, 0805=2.2μF, 1206=10μF, 1210=10μF																																																																											
16V : 0402=0.22μF, 0603=1μF, 0805=2.2μF, 1206=10μF, 1210=47μF																																																																											
10V : 0402=0.47μF, 0603=0.47μF, 0805=2.2μF, 1206=4.7μF, 1210=47μF																																																																											
6.3V, 4V																																																																											
RATED VOLTAGE (X7R)		I.R.																																																																									
100V : 1210=3.3μF		RxC≥50Ω-F																																																																									
50V : 0402=1μF, 0603=2.2μF, 0805=10μF, 1206=10μF																																																																											
35V : 0603=1μF																																																																											
25V : 0402=2.2μF, 0603=10μF, 0805=10μF, 1206=22μF																																																																											
16V : 0603=10μF, 0402=1μF, 0201=0.22μF																																																																											
10V : 0402=1μF, 0603=10μF, 0805=47μF																																																																											
6.3V : 0603=4.7μF, 0805=47μF, 1206=10μF																																																																											
4V : 0603=22μF, 0805=47μF, 1206=100μF																																																																											



RELIABILITY TEST CONDITIONS AND REQUIREMENTS

NO.	ITEM	TEST CONDITION	REQUIREMENTS															
6.	Dielectric Strength	<table border="1"> <thead> <tr> <th>RATED VOLTAGE</th> <th>CONDITION</th> </tr> </thead> <tbody> <tr> <td>≤100</td> <td>2.5 times of U_r</td> </tr> <tr> <td>100<math>V</math>≤500</td> <td>2.0 times of U_r</td> </tr> <tr> <td>250<math>V</math>≤500</td> <td>1.5 times of U_r</td> </tr> <tr> <td>630<math>V</math>≤3000V</td> <td>1.2 times of U_r</td> </tr> <tr> <td>3000<math>V</math>≤5000V</td> <td>1.1 times of U_r</td> </tr> <tr> <td>≥5000V</td> <td>1.0 times of U_r</td> </tr> </tbody> </table> <p>- Duration : 1 to 5 sec. Voltage ramp up rate ≤500Vd/sec. - Charge and discharge current less than 50mA. - Test in insulating fluid for rated voltage ≥1KV products</p>	RATED VOLTAGE	CONDITION	≤100	2.5 times of U_r	100V≤500	2.0 times of U_r	250V≤500	1.5 times of U_r	630V≤3000V	1.2 times of U_r	3000V≤5000V	1.1 times of U_r	≥5000V	1.0 times of U_r	- No evidence of damage or flash over during test.	
RATED VOLTAGE	CONDITION																	
≤100	2.5 times of U_r																	
100V≤500	2.0 times of U_r																	
250V≤500	1.5 times of U_r																	
630V≤3000V	1.2 times of U_r																	
3000V≤5000V	1.1 times of U_r																	
≥5000V	1.0 times of U_r																	
7.	Solderability	- Solder temperature : 235±5°C for (0402~1210). - Solder temperature : 245±5°C for (1808~2225). - Dipping time : 2±0.5 sec.	- 75% min. coverage of all metalized area															
8.	Resistance to Soldering Heat	- Solder temperature : 260±5°C. - Dipping time : 10±1 sec. - Preheating : 120 to 150°C for 1 minute before immerse the capacitor in a eutectic solder. - Before initial measurement (Class II only) : To apply de-aging at 150°C for 1hr then set for 24±2 hrs at room temp. - Measurement to be made after keeping at room temp. for 24±2 hrs (Class I) or 48±4 hrs (Class II).	- No remarkable damage. - Cap. change : COG : Within ±2.5% or ±0.25pF, whichever is larger. X7R : Within ±7.5%. - D.F./Q, I.R. : To meet initial requirements. - 25% max. leaching on each edge.															
9.	Temperature Cycle	- Conduct the five cycles according to the temperatures and time <table border="1"> <thead> <tr> <th>STEP</th> <th>TEMP. (°C)</th> <th>TIME (MIN.)</th> </tr> </thead> <tbody> <tr> <td>1</td> <td>Min. operating temp. +0/-3</td> <td>30±3</td> </tr> <tr> <td>2</td> <td>Room Temp.</td> <td>2-3</td> </tr> <tr> <td>3</td> <td>Max. operating temp. +3/-0</td> <td>30±3</td> </tr> <tr> <td>4</td> <td>Room Temp.</td> <td>2-3</td> </tr> </tbody> </table> <p>- Before initial measurement (Class II only) : To apply de-aging at 150°C for 1hr then set for 24±2 hrs at room temp. - Measurement to be made after keeping at room temp. for 24±2 hrs (Class I) or 48±4 hrs (Class II).</p>	STEP	TEMP. (°C)	TIME (MIN.)	1	Min. operating temp. +0/-3	30±3	2	Room Temp.	2-3	3	Max. operating temp. +3/-0	30±3	4	Room Temp.	2-3	- No remarkable damage. - Cap. change : COG : Within ±2.5% or ±0.25pF, whichever is larger. X7R : Within ±7.5%. - D.F./Q : COG : Q≥100% of initial requirements. X7R : D.F.≤150% of initial requirement. - I.R. : ≥100% of initial requirement.
STEP	TEMP. (°C)	TIME (MIN.)																
1	Min. operating temp. +0/-3	30±3																
2	Room Temp.	2-3																
3	Max. operating temp. +3/-0	30±3																
4	Room Temp.	2-3																
10.	Humidity (Damp Heat) Steady State	- Test temp. : 40±2°C. - Humidity : 90~95%RH. - Test time : 500 +24/-0hrs. - Before initial measurement (Class II only) : To apply de-aging at 150°C for 1hr then set for 24±2 hrs at room temp. - Measurement to be made after keeping at room temp. for 24±2 hrs (Class I) or 48±4 hrs (Class II).	- No remarkable damage. - Cap. change : COG : Within ±5.0% or ±0.5pF, whichever is larger. X7R : Within ±12.5% for ≥10V**, within ±25% for 6.3V. **10V : Within ±25% for 0603≥4.7μF, 0402≥1μF. - D.F./Q : COG : Q≥350 for Cap.>30pF, Q≥275+2.5C for 10pF≤Cap.≤30pF, Q≥200+10C for Cap.<10pF. X7R : D.F.≤200% of initial requirement. - I.R. : ≥10V, ≥1GΩ or RxC≥50Ω-F, whichever is smaller Except:															
		<table border="1"> <thead> <tr> <th>RATED VOLTAGE (X7R)</th> <th>I.R.</th> </tr> </thead> <tbody> <tr> <td>100V : All X7R; 1210≥3.3μF</td> <td rowspan="6">≥1GΩ or RxC ≥ 10Ω-F, whichever is smaller</td> </tr> <tr> <td>50V : 0402>0.01μF, 0603≥1μF, 0805≥1μF, 1206≥4.7μF, 1210≥4.7μF</td> </tr> <tr> <td>35V : 0603≥1μF, 0805≥2.2μF, 1206≥2.2μF, 1210≥10μF</td> </tr> <tr> <td>25V : 0402≥0.22μF, 0603≥2.2μF, 0805≥2.2μF, 1206≥10μF, 1210≥10μF</td> </tr> <tr> <td>16V : 0402≥0.22μF, 0603≥1μF, 0805≥2.2μF, 1206≥10μF, 1210≥47μF</td> </tr> <tr> <td>10V : 0402≥0.47μF, 0603≥0.47μF, 0805≥2.2μF, 1206≥4.7μF, 1210≥47μF</td> </tr> <tr> <td colspan="2">6.3V; 4V; Size≥1812</td> </tr> </tbody> </table>	RATED VOLTAGE (X7R)	I.R.	100V : All X7R; 1210≥3.3μF	≥1GΩ or RxC ≥ 10Ω-F, whichever is smaller	50V : 0402>0.01μF, 0603≥1μF, 0805≥1μF, 1206≥4.7μF, 1210≥4.7μF	35V : 0603≥1μF, 0805≥2.2μF, 1206≥2.2μF, 1210≥10μF	25V : 0402≥0.22μF, 0603≥2.2μF, 0805≥2.2μF, 1206≥10μF, 1210≥10μF	16V : 0402≥0.22μF, 0603≥1μF, 0805≥2.2μF, 1206≥10μF, 1210≥47μF	10V : 0402≥0.47μF, 0603≥0.47μF, 0805≥2.2μF, 1206≥4.7μF, 1210≥47μF	6.3V; 4V; Size≥1812						
RATED VOLTAGE (X7R)	I.R.																	
100V : All X7R; 1210≥3.3μF	≥1GΩ or RxC ≥ 10Ω-F, whichever is smaller																	
50V : 0402>0.01μF, 0603≥1μF, 0805≥1μF, 1206≥4.7μF, 1210≥4.7μF																		
35V : 0603≥1μF, 0805≥2.2μF, 1206≥2.2μF, 1210≥10μF																		
25V : 0402≥0.22μF, 0603≥2.2μF, 0805≥2.2μF, 1206≥10μF, 1210≥10μF																		
16V : 0402≥0.22μF, 0603≥1μF, 0805≥2.2μF, 1206≥10μF, 1210≥47μF																		
10V : 0402≥0.47μF, 0603≥0.47μF, 0805≥2.2μF, 1206≥4.7μF, 1210≥47μF																		
6.3V; 4V; Size≥1812																		
11.	Humidity (Damp Heat) Load	- Reflow solder the capacitors on a P.C. Board before test. - Test temp. : 40±2°C (85±3°C for control code H). - Humidity : 90~95% RH (85±5% for control code H). - Test time : 500 +24/-0hrs. - To apply voltage : Rated voltage (500Vdc max. for general purpose and 100Vdc max. for control code H) - Measurement to be made after keeping at room temp. for 24±2 hrs (Class I) or 48±4 hrs (Class II).	- No remarkable damage. - Cap. change : COG : Within ±7.5% or ±0.75pF, whichever is larger. X7R : Within ±12.5% for ≥10V**, within ±25% for 6.3V. **10V : Within ±25% for 0603≥4.7μF, 0402≥1μF. - D.F./Q : COG : Q≥350 for Cap.>30pF, Q≥275+2.5C for 10pF≤Cap.≤30pF, Q≥200+10C for Cap.<10pF. X7R : ≤200% of initial requirement. - I.R. : ≥10V, ≥500MΩ or RxC≥25Ω-F, whichever is smaller. Except:															
		<table border="1"> <thead> <tr> <th>RATED VOLTAGE (X7R)</th> <th>I.R.</th> </tr> </thead> <tbody> <tr> <td>≥100V : All X7R; 1210≥3.3μF</td> <td rowspan="6">≥500MΩ or RxC≥5Ω-F, whichever is smaller</td> </tr> <tr> <td>50V : 0402>0.01μF, 0603≥1μF, 0805≥1μF, 1206≥4.7μF, 1210≥4.7μF</td> </tr> <tr> <td>35V : 0603≥1μF, 0805≥2.2μF, 1206≥2.2μF, 1210≥10μF</td> </tr> <tr> <td>25V : 0402≥0.22μF, 0603≥2.2μF, 0805≥2.2μF, 1206≥10μF, 1210≥10μF</td> </tr> <tr> <td>16V : 0402≥0.22μF, 0603≥1μF, 0805≥2.2μF, 1206≥10μF, 1210≥47μF</td> </tr> <tr> <td>10V : 0402≥0.47μF, 0603≥0.47μF, 0805≥2.2μF, 1206≥4.7μF, 1210≥47μF</td> </tr> <tr> <td colspan="2">6.3V; 4V; Size≥1812</td> </tr> </tbody> </table>	RATED VOLTAGE (X7R)	I.R.	≥100V : All X7R; 1210≥3.3μF	≥500MΩ or RxC≥5Ω-F, whichever is smaller	50V : 0402>0.01μF, 0603≥1μF, 0805≥1μF, 1206≥4.7μF, 1210≥4.7μF	35V : 0603≥1μF, 0805≥2.2μF, 1206≥2.2μF, 1210≥10μF	25V : 0402≥0.22μF, 0603≥2.2μF, 0805≥2.2μF, 1206≥10μF, 1210≥10μF	16V : 0402≥0.22μF, 0603≥1μF, 0805≥2.2μF, 1206≥10μF, 1210≥47μF	10V : 0402≥0.47μF, 0603≥0.47μF, 0805≥2.2μF, 1206≥4.7μF, 1210≥47μF	6.3V; 4V; Size≥1812						
RATED VOLTAGE (X7R)	I.R.																	
≥100V : All X7R; 1210≥3.3μF	≥500MΩ or RxC≥5Ω-F, whichever is smaller																	
50V : 0402>0.01μF, 0603≥1μF, 0805≥1μF, 1206≥4.7μF, 1210≥4.7μF																		
35V : 0603≥1μF, 0805≥2.2μF, 1206≥2.2μF, 1210≥10μF																		
25V : 0402≥0.22μF, 0603≥2.2μF, 0805≥2.2μF, 1206≥10μF, 1210≥10μF																		
16V : 0402≥0.22μF, 0603≥1μF, 0805≥2.2μF, 1206≥10μF, 1210≥47μF																		
10V : 0402≥0.47μF, 0603≥0.47μF, 0805≥2.2μF, 1206≥4.7μF, 1210≥47μF																		
6.3V; 4V; Size≥1812																		



NO.	ITEM	TEST CONDITION	REQUIREMENTS																																																																																																									
12.	High Temperature Load (Endurance)	<p>- Test temp. : 125±3°C.</p> <p>- To apply voltage :</p> <p>(1) ≤6.3V or Cap.≥10µF : 150% of rated voltage.</p> <p>(2) 10V≤Ur≤100V : 200% of rated voltage.</p> <p>(3) 200V≤Ur≤500V : 150% of rated voltage.</p> <p>(4) 630V : 120% of rated voltage.</p> <p>(5) Ur≥1000V : 100% of rated voltage.</p> <p>(6) 100% of rated voltage for below range:</p> <table border="1"> <thead> <tr> <th>SIZE</th> <th>DIELECTRIC</th> <th>RATED</th> <th>CAPACITANCE</th> </tr> </thead> <tbody> <tr> <td rowspan="2">0402</td> <td rowspan="2">X7R</td> <td>6.3V, 10V, 16V, 25V</td> <td>C≥1.0µF</td> </tr> <tr> <td>4V</td> <td>C≥22µF</td> </tr> <tr> <td rowspan="2">0603</td> <td rowspan="2">X7R</td> <td>6.3V, 10V</td> <td>C≥4.7µF</td> </tr> <tr> <td>25V, 35V</td> <td>C≥1.0µF</td> </tr> <tr> <td rowspan="3">0805</td> <td rowspan="3">X7R</td> <td>4V</td> <td>C≥47µF</td> </tr> <tr> <td>6.3V</td> <td>C≥22µF</td> </tr> <tr> <td>10V-50V</td> <td>C≥10µF</td> </tr> <tr> <td rowspan="2">1206</td> <td rowspan="2">X7R</td> <td>≤6.3V</td> <td>C≥47µF</td> </tr> <tr> <td>100V</td> <td>C≥2.2µF</td> </tr> <tr> <td rowspan="2">1210</td> <td rowspan="2">X7R</td> <td>16V</td> <td>C≥47µF</td> </tr> <tr> <td>≥100V</td> <td>C≥3.3µF</td> </tr> <tr> <td>2220</td> <td>X7R</td> <td>100V</td> <td>C≥22µF</td> </tr> </tbody> </table> <p>(7) 150% of rated voltage for below range:</p> <table border="1"> <thead> <tr> <th>SIZE</th> <th>DIELECTRIC</th> <th>RATED</th> <th>CAPACITANCE</th> </tr> </thead> <tbody> <tr> <td rowspan="2">0402</td> <td rowspan="2">X7R</td> <td>50V</td> <td>C≥0.1µF</td> </tr> <tr> <td>10-25V</td> <td>C≥0.22µF</td> </tr> <tr> <td rowspan="2">0603</td> <td rowspan="2">X7R</td> <td>≥50V</td> <td>C≥0.082µF</td> </tr> <tr> <td>10V, 16V, 50V</td> <td>C≥1.0µF</td> </tr> <tr> <td rowspan="3">0805</td> <td rowspan="3">X7R</td> <td>10-50V</td> <td>C≥4.7µF</td> </tr> <tr> <td>50V</td> <td>C≥0.47µF</td> </tr> <tr> <td>≥100V</td> <td>C≥0.12µF</td> </tr> <tr> <td rowspan="2">1206</td> <td rowspan="2">X7R</td> <td>≥50V</td> <td>C≥1.0µF</td> </tr> <tr> <td>≤100V</td> <td>C≥1.0µF</td> </tr> <tr> <td rowspan="2">1210</td> <td rowspan="2">X7R</td> <td>>100V</td> <td>C≥0.22µF</td> </tr> <tr> <td>≤50V</td> <td>C≥4.7µF</td> </tr> <tr> <td>1825</td> <td rowspan="2">X7R</td> <td>100V</td> <td>C≥1.0µF</td> </tr> <tr> <td>2220</td> <td>≥100V</td> <td>C≥1.0µF</td> </tr> <tr> <td>2225</td> <td>X7R</td> <td>≥100V</td> <td>C≥1.0µF</td> </tr> </tbody> </table> <p>(8) 120% of rated voltage for below range:</p> <table border="1"> <thead> <tr> <th>SIZE</th> <th>DIELECTRIC</th> <th>RATED</th> <th>CAPACITANCE</th> </tr> </thead> <tbody> <tr> <td>2220</td> <td>X7R</td> <td>≥100V</td> <td>C≥15µF</td> </tr> </tbody> </table> <p>- Test time : 1000 +24/-0 hrs.</p> <p>- Before initial measurement (Class II only) : To apply deaging at 150°C for 1hr then set for 24±2 hrs at room temp.</p> <p>- Measurement to be made after keeping at room temp. for 48±4 hrs (Class II).</p> <p>- De-rating conditions :</p>	SIZE	DIELECTRIC	RATED	CAPACITANCE	0402	X7R	6.3V, 10V, 16V, 25V	C≥1.0µF	4V	C≥22µF	0603	X7R	6.3V, 10V	C≥4.7µF	25V, 35V	C≥1.0µF	0805	X7R	4V	C≥47µF	6.3V	C≥22µF	10V-50V	C≥10µF	1206	X7R	≤6.3V	C≥47µF	100V	C≥2.2µF	1210	X7R	16V	C≥47µF	≥100V	C≥3.3µF	2220	X7R	100V	C≥22µF	SIZE	DIELECTRIC	RATED	CAPACITANCE	0402	X7R	50V	C≥0.1µF	10-25V	C≥0.22µF	0603	X7R	≥50V	C≥0.082µF	10V, 16V, 50V	C≥1.0µF	0805	X7R	10-50V	C≥4.7µF	50V	C≥0.47µF	≥100V	C≥0.12µF	1206	X7R	≥50V	C≥1.0µF	≤100V	C≥1.0µF	1210	X7R	>100V	C≥0.22µF	≤50V	C≥4.7µF	1825	X7R	100V	C≥1.0µF	2220	≥100V	C≥1.0µF	2225	X7R	≥100V	C≥1.0µF	SIZE	DIELECTRIC	RATED	CAPACITANCE	2220	X7R	≥100V	C≥15µF	<p>- No remarkable damage.</p> <p>- Cap. change :</p> <p>COG : Within ±5.0% or ±0.5pF, whichever is larger.</p> <p>X7R : Within ±12.5% for ≥10V**, within ±25% for 6.3V.</p> <p>**10V : Within ±25% for 0603≥4.7µF, 0402≥1µF.</p> <p>- D.F./Q :</p> <p>COG : Q≥350 for Cap.>30pF, Q≥275+2.5C for 10pF≤Cap.≤30pF, Q≥200+10C for Cap.<10pF.</p> <p>X7R : D.F.≤200% of initial requirement.</p> <p>- I.R. : ≥10V, ≥1GΩ or RxC≥50Ω-F, whichever is smaller.</p> <p>Except:</p> <table border="1"> <thead> <tr> <th>RATED VOLTAGE</th> <th>I.R.</th> </tr> </thead> <tbody> <tr> <td>100V : All X7R; 1210≥3.3µF</td> <td rowspan="10">≥1GΩ or RxC≥100-F, whichever is smaller</td> </tr> <tr> <td>50V : 0402≥0.01µF, 0603≥1µF, 0805≥1µF, 1206≥4.7µF, 1210≥4.7µF</td> </tr> <tr> <td>35V : 0603≥1µF, 0805≥2.2µF, 1206≥2.2µF, 1210≥10µF</td> </tr> <tr> <td>25V : 0402≥0.22µF, 0603≥2.2µF, 0805≥2.2µF, 1206≥10µF, 1210≥10µF</td> </tr> <tr> <td>16V : 0402≥0.22µF, 0603≥1µF, 0805≥2.2µF, 1206≥10µF, 1210≥47µF</td> </tr> <tr> <td>10V : 0402≥0.47µF, 0603≥0.47µF, 0805≥2.2µF, 1206≥4.7µF, 1210≥47µF</td> </tr> <tr> <td>6.3V, 4V, Size≥1812</td> </tr> </tbody> </table>	RATED VOLTAGE	I.R.	100V : All X7R; 1210≥3.3µF	≥1GΩ or RxC≥100-F, whichever is smaller	50V : 0402≥0.01µF, 0603≥1µF, 0805≥1µF, 1206≥4.7µF, 1210≥4.7µF	35V : 0603≥1µF, 0805≥2.2µF, 1206≥2.2µF, 1210≥10µF	25V : 0402≥0.22µF, 0603≥2.2µF, 0805≥2.2µF, 1206≥10µF, 1210≥10µF	16V : 0402≥0.22µF, 0603≥1µF, 0805≥2.2µF, 1206≥10µF, 1210≥47µF	10V : 0402≥0.47µF, 0603≥0.47µF, 0805≥2.2µF, 1206≥4.7µF, 1210≥47µF	6.3V, 4V, Size≥1812
SIZE	DIELECTRIC	RATED	CAPACITANCE																																																																																																									
0402	X7R	6.3V, 10V, 16V, 25V	C≥1.0µF																																																																																																									
		4V	C≥22µF																																																																																																									
0603	X7R	6.3V, 10V	C≥4.7µF																																																																																																									
		25V, 35V	C≥1.0µF																																																																																																									
0805	X7R	4V	C≥47µF																																																																																																									
		6.3V	C≥22µF																																																																																																									
		10V-50V	C≥10µF																																																																																																									
1206	X7R	≤6.3V	C≥47µF																																																																																																									
		100V	C≥2.2µF																																																																																																									
1210	X7R	16V	C≥47µF																																																																																																									
		≥100V	C≥3.3µF																																																																																																									
2220	X7R	100V	C≥22µF																																																																																																									
SIZE	DIELECTRIC	RATED	CAPACITANCE																																																																																																									
0402	X7R	50V	C≥0.1µF																																																																																																									
		10-25V	C≥0.22µF																																																																																																									
0603	X7R	≥50V	C≥0.082µF																																																																																																									
		10V, 16V, 50V	C≥1.0µF																																																																																																									
0805	X7R	10-50V	C≥4.7µF																																																																																																									
		50V	C≥0.47µF																																																																																																									
		≥100V	C≥0.12µF																																																																																																									
1206	X7R	≥50V	C≥1.0µF																																																																																																									
		≤100V	C≥1.0µF																																																																																																									
1210	X7R	>100V	C≥0.22µF																																																																																																									
		≤50V	C≥4.7µF																																																																																																									
1825	X7R	100V	C≥1.0µF																																																																																																									
2220		≥100V	C≥1.0µF																																																																																																									
2225	X7R	≥100V	C≥1.0µF																																																																																																									
SIZE	DIELECTRIC	RATED	CAPACITANCE																																																																																																									
2220	X7R	≥100V	C≥15µF																																																																																																									
RATED VOLTAGE	I.R.																																																																																																											
100V : All X7R; 1210≥3.3µF	≥1GΩ or RxC≥100-F, whichever is smaller																																																																																																											
50V : 0402≥0.01µF, 0603≥1µF, 0805≥1µF, 1206≥4.7µF, 1210≥4.7µF																																																																																																												
35V : 0603≥1µF, 0805≥2.2µF, 1206≥2.2µF, 1210≥10µF																																																																																																												
25V : 0402≥0.22µF, 0603≥2.2µF, 0805≥2.2µF, 1206≥10µF, 1210≥10µF																																																																																																												
16V : 0402≥0.22µF, 0603≥1µF, 0805≥2.2µF, 1206≥10µF, 1210≥47µF																																																																																																												
10V : 0402≥0.47µF, 0603≥0.47µF, 0805≥2.2µF, 1206≥4.7µF, 1210≥47µF																																																																																																												
6.3V, 4V, Size≥1812																																																																																																												

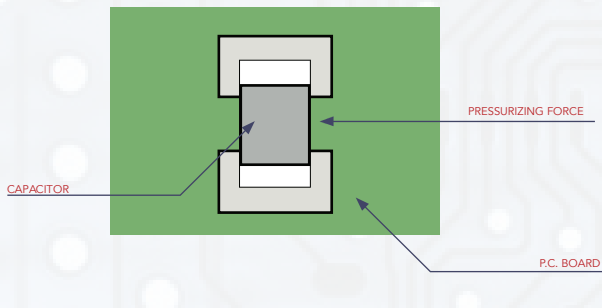
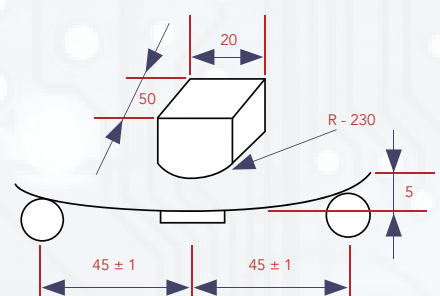

RELIABILITY TEST CONDITIONS AND REQUIREMENTS

NO.	ITEM	TEST CONDITION	REQUIREMENTS						
13.	Adhesive Strength of Termination	<p>- Capacitors mounted on a substrate. A force of 5N(≤ 0603) or 10N(>0603) applied perpendicular to the place of substrate and parallel the line joining the center of terminations for 10 ± 1 second</p> 	<p>- No remarkable damage or removal of the terminations</p>						
14.	Bending Test	<p>- The middle part of substrate shall be pressurized by means of the pressurizing rod at a rate of about 1mm per second until the deflection becomes 5mm for product size < 1808, 3mm for product size ≥ 1808</p> 	<p>- No remarkable damage.</p> <table border="1" data-bbox="966 640 1550 745"> <thead> <tr> <th>DIELECTRIC</th> <th>CAP. CHANGE</th> </tr> </thead> <tbody> <tr> <td>Class I (C0G)</td> <td>Within $\pm 5.0\%$ or $\pm 0.5\text{pF}$, whichever is larger</td> </tr> <tr> <td>Class II (X7R)</td> <td>Within $\pm 12.5\%$</td> </tr> </tbody> </table> <p>- This capacitance change means the change of capacitance under specified flexure of substrate from the before test initial measurement</p>	DIELECTRIC	CAP. CHANGE	Class I (C0G)	Within $\pm 5.0\%$ or $\pm 0.5\text{pF}$, whichever is larger	Class II (X7R)	Within $\pm 12.5\%$
DIELECTRIC	CAP. CHANGE								
Class I (C0G)	Within $\pm 5.0\%$ or $\pm 0.5\text{pF}$, whichever is larger								
Class II (X7R)	Within $\pm 12.5\%$								
15.	Vibration Resistance	<p>- Vibration frequency : 10~55 Hz/min. - Total amplitude : 1.5mm. - Test time : 6 hrs. (Two hrs each in three mutually perpendicular directions) - Before initial measurement (Class II only) : To apply de-aging at 150°C for 1hr then set for 24 ± 2 hrs at room temp. - Measurement to be made after keeping at room temp. for 24 ± 2 hrs (Class I) or 48 ± 4 hrs (Class II).</p>	<p>- No remarkable damage or removal of the terminations - Cap. change and D.F./Q : To meet initial spec.</p>						



PACKAGE DIMENSION AND QUANTITY

SIZE	THICKNESS (MM)	PAPER TAPE		PLASTIC TAPE	
		7" REEL	13" REEL	7" REEL	13" REEL
0402 (1005)	0.50±0.05	10K	50K	-	-
	0.50 +0.02/-0.05	10K	50K	-	-
	0.50±0.20	10K	-	-	-
0603 (1608)	0.50±0.10	4K	-	-	-
	0.80±0.07	4K	15K	-	-
	0.80 +0.15/-0.10	4K	15K	-	-
0805 (2012)	0.50±0.10	4K	15K	-	-
	0.60±0.10	4K	15K	-	-
	0.80±0.10	4K	15K	-	-
	0.85±0.10	4K	15K	-	-
	1.25±0.10	-	-	3K	10K
	1.25±0.20	-	-	3K	10K
	1.60±0.20	-	-	2K	10K
1206 (3216)	0.80±0.10	4K	15K	-	-
	0.85±0.10	4K	15K	-	-
	0.95±0.10	-	-	3K	10K
	1.15±0.15	-	-	3K	10K
	1.25±0.10	-	-	3K	10K
	1.60±0.20	-	-	2K	10K
	1.60 +0.30/-0.10	-	-	2K	9K
1210 (3225)	0.85±0.10	-	-	3K	10K
	0.95±0.10	-	-	3K	10K
	1.25±0.10	-	-	3K	10K
	1.60±0.20	-	-	2K	-
	2.00±0.20	-	-	1K	6K
	2.50±0.30	-	-	1K	6K
1808 (4520)	1.25±0.10	-	-	2K	10K
	1.60±0.20	-	-	2K	8K
	2.00±0.20	-	-	1K	6K
1812 (4532)	1.25±0.10	-	-	1K	5K
	1.60±0.20	-	-	1K	-
	2.00±0.20	-	-	1K	-
	2.50±0.30	-	-	0.5K	3K
	2.80±0.30	-	-	0.5K	-
1825 (4563)	1.60±0.20	-	-	1K	-
	2.00±0.20	-	-	1K	-
	2.50±0.30	-	-	0.5K	-
	2.80±0.30	-	-	0.5K	-
2220 (5750)	1.60±0.20	-	-	1K	-
	2.00±0.20	-	-	1K	-
	2.50±0.30	-	-	0.5K	-
	2.80±0.30	-	-	0.5K	-
	3.10±0.30	-	-	-	1K
2225 (5763)	1.60±0.20	-	-	1K	-
	2.00±0.20	-	-	1K	-
	2.50±0.30	-	-	0.5K	-
	2.80±0.30	-	-	0.5K	-

PACKAGE DIMENSION AND QUANTITY

- Embossed Tape Dimensions

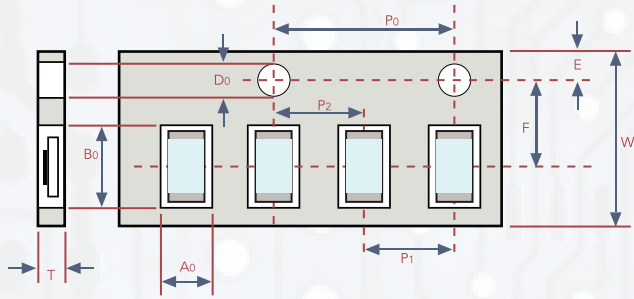

Dimension of paper tape

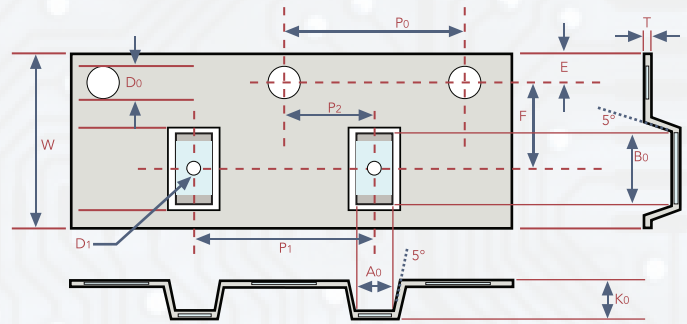

Dimension of plastic tape

SIZE	CHIP THICKNESS	A_0	B_0	T	K_0	W	P_0	$10X P_0$	P_1	P_2	D_0	D_1	E	F	UNIT
0402	0.50±0.05	0.70±0.20	1.20±0.20	≤0.80	-	8.00±0.10	4.00±0.10	40.00±0.10	2.00±0.05	2.00±0.05	1.55±0.05	-	1.75±0.05	3.50±0.05	MM
	0.50±0.10	0.70±0.20	1.20±0.20	≤0.80	-	8.00±0.10	4.00±0.10	40.00±0.10	2.00±0.05	2.00±0.05	1.55±0.05	-	1.75±0.05	3.50±0.05	MM
0603	0.80±0.07	1.00 +0.05/-0.1	1.80±0.10	0.95±0.05	-	8.00±0.10	4.00±0.10	40.00±0.20	4.00±0.10	2.00±0.05	1.55±0.05	-	1.75±0.05	3.50±0.05	MM
	0.80 +0.15/-0.1	1.02 +0.05/-0.1	1.80±0.10	0.97±0.05	-	8.00±0.10	4.00±0.10	40.00±0.20	4.00±0.10	2.00±0.05	1.55±0.05	-	1.75±0.05	3.50±0.05	MM
0805	0.80±0.10	1.50±0.10	2.30±0.10	0.95±0.05	-	8.00±0.10	4.00±0.10	40.00±0.20	4.00±0.10	2.00±0.05	1.55±0.05	-	1.75±0.05	3.50±0.05	MM
	1.25±0.10 1.25±0.20	<1.65	<2.40	0.23±0.05	<2.50	8.00±0.10	4.00±0.10	40.00±0.20	4.00±0.10	2.00±0.05	1.50 +0.10/-0	1.00±0.10	1.75±0.10	3.50±0.05	MM
1206	0.80±0.10	2.00±0.10	3.50±0.50	0.95±0.05	<2.50	8.00±0.10	4.00±0.10	40.00±0.20	4.00±0.10	2.00±0.05	1.55±0.05	-	1.75±0.10	3.50±0.05	MM
	0.95±0.10 1.25±0.10	<2.00	<3.70	0.23±0.05	<2.50	8.00±0.10	4.00±0.10	40.00±0.20	4.00±0.10	2.00±0.05	1.50 +0.10/-0	1.00±0.10	1.75±0.10	3.50±0.05	MM
	1.60±0.20 1.60±0.3/-0/1	<2.50	<4.00	0.23±0.05	<2.50	12.00±0.20	4.00±0.10	40.00±0.20	4.00±0.10	2.00±0.05	1.50±0.10/-0	1.50±0.10	1.75±0.10	5.50±0.05	MM
1210	1.25±0.10 1.60±0.20	<2.50	<4.00	0.23±0.05	<2.50	12.00±0.20	4.00±0.10	40.00±0.20	4.00±0.10	2.00±0.05	1.50±0.10/-0	1.50±0.10	1.75±0.10	5.50±0.05	MM
	2.50±0.30	<3.10	<4.00	0.23±0.05	<2.50	12.00±0.20	4.00±0.10	40.00±0.20	4.00±0.10	2.00±0.05	1.50 +0.10/-0	1.00±0.10	1.75±0.10	5.50±0.05	MM
1808	1.25±0.10 1.60±0.20	<2.50	<5.30	0.25±0.05	<2.50	12.00±0.20	4.00±0.10	40.00±0.20	4.00±0.10	2.00±0.05	1.50±0.10/-0	1.50±0.10	1.75±0.10	5.50±0.05	MM
	2.00±0.20	<2.50	<5.30	0.25±0.05	<2.50	12.00±0.20	4.00±0.10	40.00±0.20	4.00±0.10	2.00±0.05	1.50±0.10/-0	1.50±0.10	1.75±0.10	5.50±0.05	MM
1812	1.25±0.10 1.60±0.20 2.00±0.20	<3.90	<5.30	0.25±0.05	<2.50	12.00±0.20	4.00±0.10	40.00±0.20	8.00±0.10	2.00±0.05	1.50 +0.10/-0	1.50±0.10	1.75±0.10	5.50±0.05	MM
	2.50±0.30 2.80±0.30	<3.90	<5.30	0.25±0.05	<3.00	12.00±0.20	4.00±0.10	40.00±0.20	8.00±0.10	2.00±0.05	1.50 +0.10/-0	1.50±0.10	1.75±0.10	5.50±0.05	MM
1825	1.60±0.20 2.00±0.20	<6.80	<5.30	0.30±0.10	<2.50	12.00±0.20	4.00±0.10	40.00±0.20	8.00±0.10	2.00±0.05	1.50 +0.10/-0	1.50±0.10	1.75±0.10	5.50±0.05	MM
	2.50±0.30 2.80±0.30	<6.80	<5.30	0.30±0.10	<3.10	12.00±0.20	4.00±0.10	40.00±0.20	8.00±0.10	2.00±0.05	1.50 +0.10/-0	1.50±0.10	1.75±0.10	5.50±0.05	MM
2220	1.40±0.15 1.60±0.20 2.00±0.20	<5.80	<6.50	0.30±0.10	<2.50	12.00±0.20	4.00±0.10	40.00±0.20	8.00±0.10	2.00±0.05	1.50 +0.10/-0	1.50±0.10	1.75±0.10	5.50±0.05	MM
	2.50±0.30 2.80±0.30	<6.80	<6.50	0.30±0.10	<3.10	12.00±0.20	4.00±0.10	40.00±0.20	8.00±0.10	2.00±0.05	1.50 +0.10/-0	1.50±0.10	1.75±0.10	5.50±0.05	MM
	3.10±0.30	<5.60	<6.50	0.30±0.10	<4.20	12.00±0.20	4.00±0.10	40.00±0.20	8.00±0.10	2.00±0.05	1.50 +0.10/-0	1.50±0.10	1.75±0.10	5.50±0.05	MM
2224	1.60±0.20 2.00±0.20	<6.80	<6.50	0.30±0.10	<2.50	12.00±0.20	4.00±0.10	40.00±0.20	8.00±0.10	2.00±0.05	1.50 +0.10/-0	1.50±0.10	1.75±0.10	5.50±0.05	MM
	2.50±0.30 2.80±0.30	<6.80	<6.50	0.30±0.10	<3.10	12.00±0.20	4.00±0.10	40.00±0.20	8.00±0.10	2.00±0.05	1.50 +0.10/-0	1.50±0.10	1.75±0.10	5.50±0.05	MM



PACKAGE DIMENSION AND QUANTITY

- Reel Dimensions

SIZE	REEL SIZE	C	W ₁	W	A	N
0201, 0402, 0603, 0805, 1206, 1210, 0603	7"	13.0 + 0.5/-0.2	8.4 + 1.5	14.4max	178.0 ± 0.10	60.0 + 1.0/-0
	13"	13.0 + 0.7/-0.3	8.4 + 1.5	14.4max	330.0 ± 1.0	100 ± 1.0
1808, 1812, 1825, 2220, 2225	7"	13.0 + 0.5/-0.2	12.4 + 2.0/-0	18.4max	178.0 ± 0.10	60.0 + 1.0/-0
	13"	13.5 ± 0.5	12.4 + 2.0/-0	18.4max	330.0 ± 1.0	100 ± 1.0

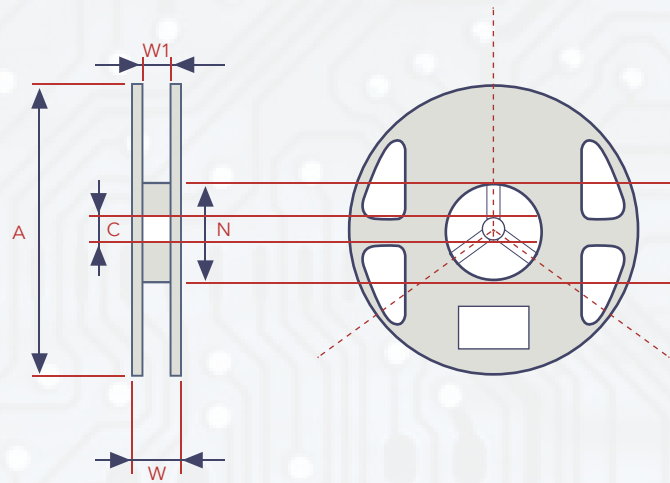

APPLICATION NOTES

STORAGE

- To prevent the damage of solderability of terminations, the following storage conditions are recommended:

- Indoors under 5 ~ 40°C and 20% ~ 70% RH.
- No harmful gases containing sulfuric acid, ammonia, hydrogen sulfide or chlorine.
- Packaging should not be opened until the capacitors are required for use. If opened, the pack should be re-sealed as soon as is practicable. Taped product should be stored out of direct sunlight, which might promote deterioration in tape or adhesion performance. The product is recommended to be used within 12 months after shipment and checked the solderability before use.

HANDLING

- Chip capacitors are dense, hard, brittle, and abrasive materials. They are liable to suffer mechanical damage, in the form of cracks or chips. Chip Capacitors should be handled with care to avoid contamination or damage. To use vacuum or plastic tweezers to pick up or plastic tweezers is recommended for manual placement. Tape and reeled packages are suitable for automatic pick and placement machine

PREHEAT

- In order to minimize the risk of thermal shock during soldering, a carefully controlled preheat is required. The rate of preheat should not exceed 3°C per second.

SOLDERING

- Use mildly activated rosin fluxes do not use activated flux. The amount of solder in each solder joint should be controlled to prevent the damage of chip capacitors caused by the stress between solder, chips, and substrate.

A) Hand Soldering:

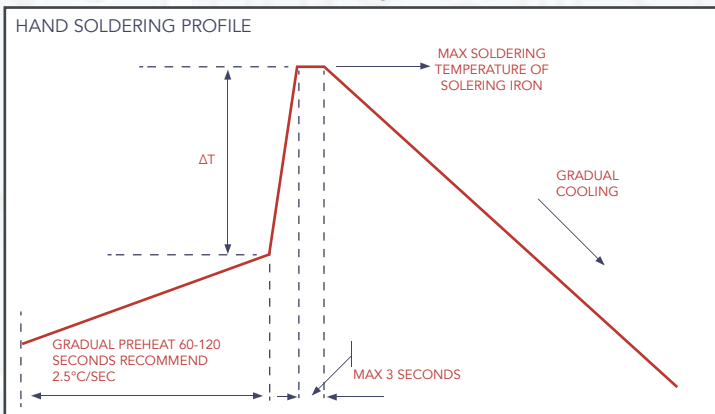

- Soldering iron tip diameter ≤ 1.0 mm and wattage max. 20W.
- The Capacitors shall be pre-heated and that the temperature gradient between the devices and the tip of the soldering iron.
- The required amount of solder shall be melted on the soldering tip.
- The tip of iron should not contact the ceramic body directly.
- The Capacitors shall be cooled gradually at room temperature after soldering.
- Forced air cooling is not allowed

CHIP SIZE	PRE-HEAT TEMP	ΔT	MAX SOLDERING IRON TEMP.
≤ 1206	$\geq 150^\circ\text{C}$	$\leq 150^\circ\text{C}$	$\leq 350^\circ\text{C}$
1210 - 2225	$\geq 150^\circ\text{C}$	$\leq 130^\circ\text{C}$	$\leq 280^\circ\text{C}$

APPLICATION NOTES

SOLDERING (cont.)

B) Reflow Soldering:

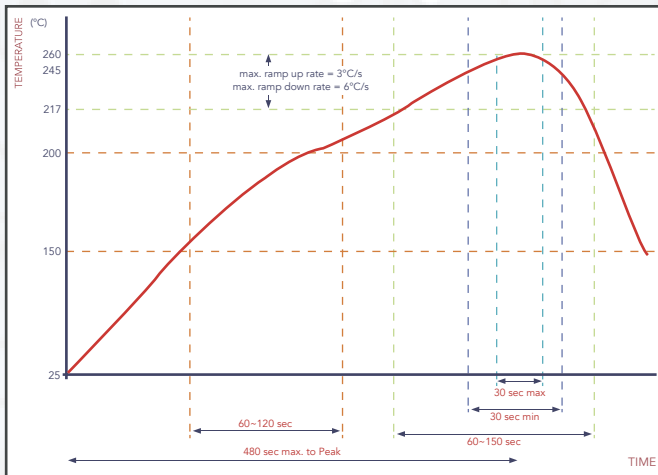

C) Wave Soldering:

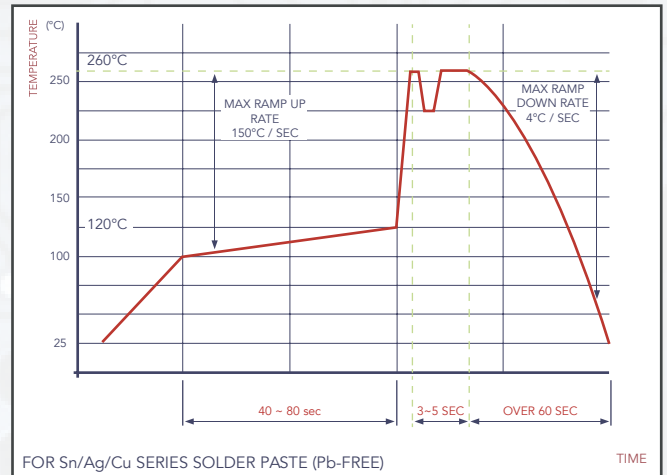

Soldering Conditions: Class I:

SIZE INCH (MM)	TEMPER. CHER.	CAPACITANCE	CONDITION	
			WAVE	REFLOW
≤0402 (1005)	Class I	ALL	X	○
0603 (1608)	Class I	ALL	○	○
0805 (2012)	Class I	ALL	○	○
1206 (3216)	Class I	ALL	○	○
		Thickness >0.95mm	X	○
≥1210 (3225)	Class I	ALL	X	○
Coating Products	ALL	ALL	X	○

SIZE INCH (MM)	TEMPER. CHER.	CAPACITANCE	CONDITION	
			WAVE	REFLOW
≤0402 (1005)	Class II	ALL	X	○
0603 (1608)	Class II	Cap. <2.2µF	○	○
		Cap. ≥2.2µF	X	○
0805 (2012)	Class II	Thickness ≤ 0.95mm	○	○
		Thickness > 0.95mm	X	○
1206 (3216)	Class II	Thickness ≤ 0.95mm	○	○
		Thickness >0.95mm	X	○
≥1210 (3225)	Class II	ALL	X	○
Coating Products	ALL	ALL	X	○

Soldering Height:

The solder climbing minimum height is suggesting to 25% of chip thickness or 500µm whichever is less. (Reference from IPC-610E)

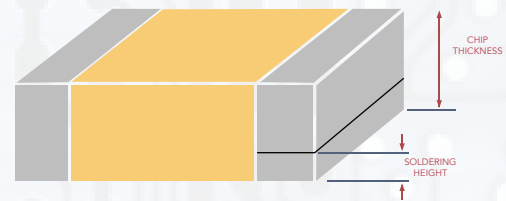

COOLING

- After soldering, cool the chips and the substrate gradually to room temperature. Natural cooling in air is recommended to minimize stress in the solder joint.

CLEANING

- All flux residues must be removed by using suitable electronic-grade vapor-cleaning solvents to eliminate contamination that could cause electrolytic surface corrosion. Good results can be obtained by using ultrasonic cleaning of the solvent. The choice of the proper system depends upon many factors such as component mix, flux, and solder paste and assembly method. The ability of the cleaning system to remove flux residues and contamination from under the chips is very important. Surface coating products are not suitable cleaning/washing by solvent



TYPICAL BENDING CRACKS OF MLCC

- MLCC ceramic body consists of rigid material. It will suffer compressive and tensional stress when the carried board is bended. If the suffered stress is over ceramic body strength, the bending crack is occurs. Therefore, the bending crack will occur after soldering process

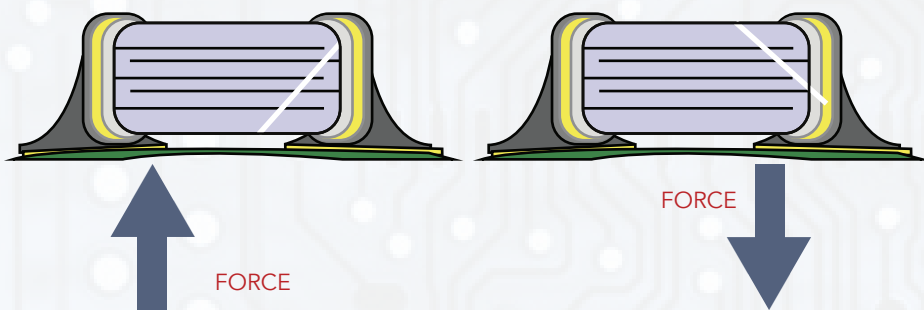

THE STRESS V.S. POSITION ON PCB DURING BENDING

- Chip mounting close to board separation point

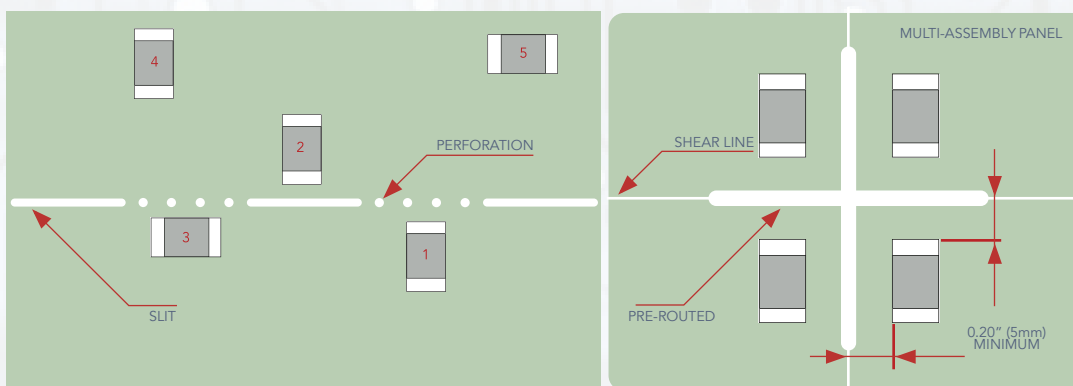

- Magnitude of stress $1 > 2 \approx 3 > 4 > 5$

STRUCTURE

- PDC soft termination series added a special termination material(Ultra-Buffer or Anti-Bend)between ceramic body and Ni-barrier that can absorb mechanical stress to prevent bending crack from occurring.

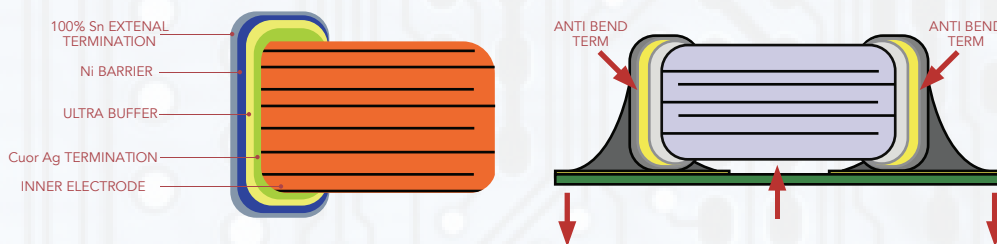
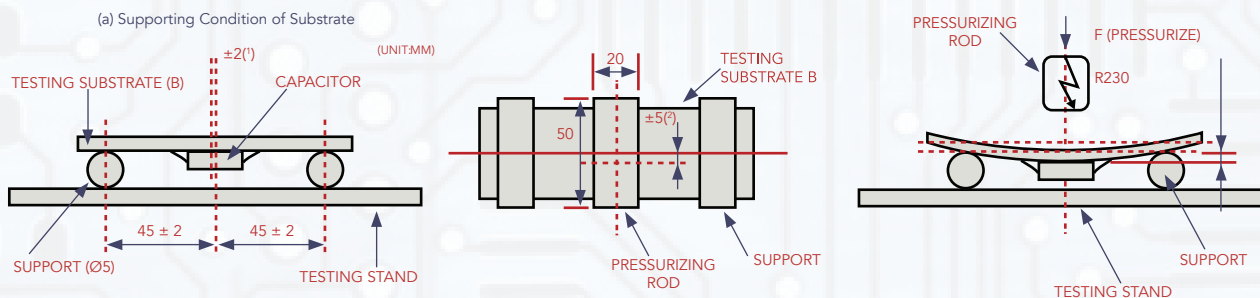

ILLUSTRATION OF BENDING TEST



Discrepancy between center of supports and center of substrate

Discrepancy between center of testing substrate A and center of pressurizing rod