

TOP LED - 3528 - BLUE

- CC - BNRA3528TS - CE -

FEATURES

- Viewing angle: 120 deg
- The materials of the LED dice is InGaN
- 3.50mm x 2.80mm x 1.90mm
- RoHS compliant led-free soldering compatible

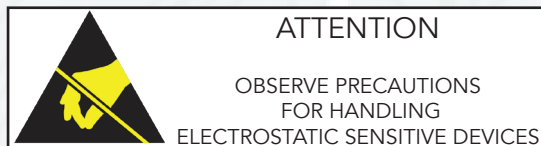

PACKAGE OUTLINE

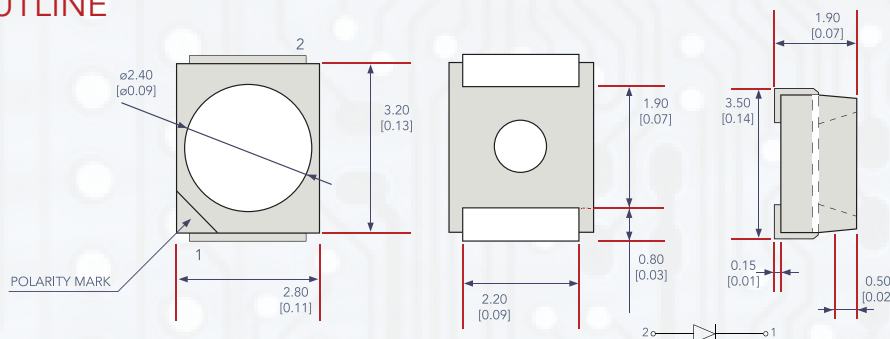

- All dimensions are in millimeters (inches)
- Tolerances are $\pm 0.2\text{mm}$ unless otherwise noted

ABSOLUTE MAXIMUM RATINGS AT $T_a - 25^\circ\text{C}$

PARAMETER	SYMBOL	VALUE	UNIT
Forward Current	I_f	30	mA
Reverse Voltage	V_r	5	V
Operating Temperature Range	T_{op}	-20 ~ +85	$^\circ\text{C}$
Storage Temperature Range	T_{stg}	-35 ~ +85	$^\circ\text{C}$
Pulse Forward Current	I_{fp}	100	mA
Electrostatic Discharge	ESD	1000 (HBM)	V

ELECTRO-OPTICAL CHARACTERISTICS AT $T_a - 25^\circ\text{C}$

PARAMETER	TEST CONDITION	SYMBOL	VALUE			UNIT
			MIN	TYPE	MAX	
Spectral Half Bandwidth	$I_f - 20\text{mA}$	$\Delta\lambda$	-	30	-	nm
Forward Voltage	$I_f - 20\text{mA}$	V_f	2.9	-	3.0	V
			3.0	-	3.1	
			3.1	-	3.2	
			3.2	-	3.3	
			3.3	-	3.4	
Dominant Wavelength	$I_f - 20\text{mA}$	λ_d	3.4	-	3.5	nm
			465	-	467.5	
			467.5	-	470	
			470	-	472.5	
Luminous Intensity	$I_f - 20\text{mA}$	I_v	472.5	-	475	mcd
			180	-	200	
			200	-	250	
			250	-	310	
Viewing Angle at 50%	$I_f - 20\text{mA}$	$2\theta_{1/2}$	-	120	-	Deg
Reverse Current	$V_r - 5\text{V}$	I_r	-	-	10	μA

NOTE: (Tolerance: $I_v \pm 10\%$, $\lambda_d \pm 2\text{nm}$, $V_f \pm 0.05\text{V}$)
 IFP Conditions: Pulse Width $\leq 10\text{m sec.}$ and Duty $\leq 1/10$.

TYPICAL OPTICAL CHARACTERISTICS CURVES

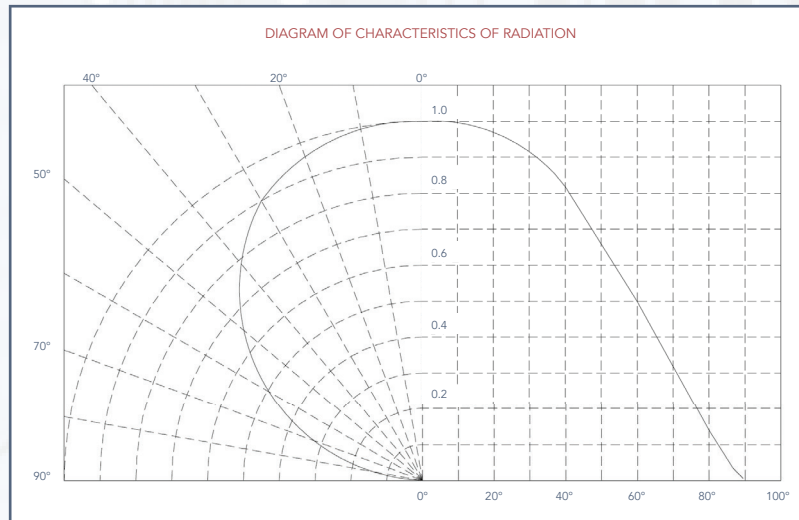
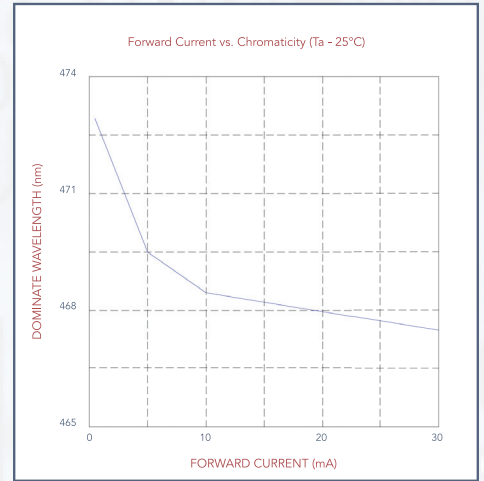
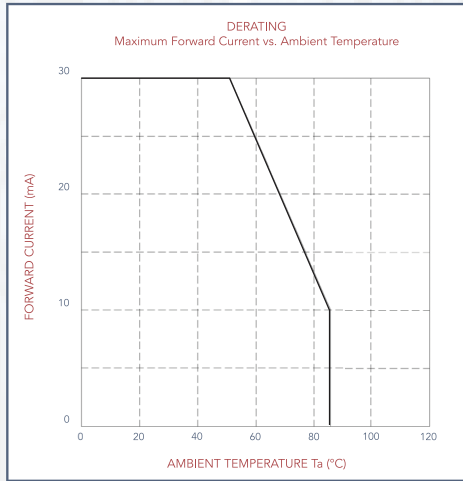
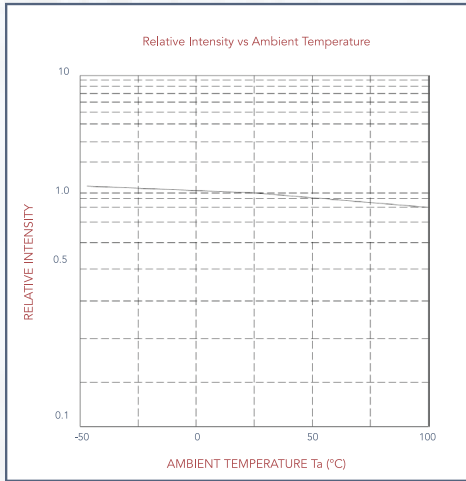
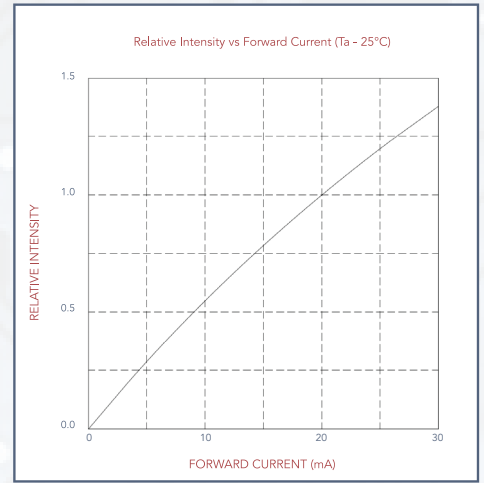
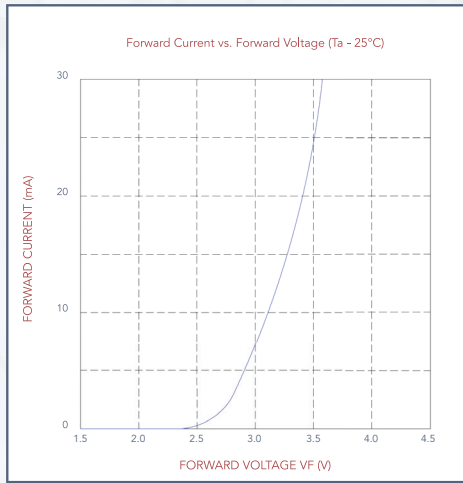
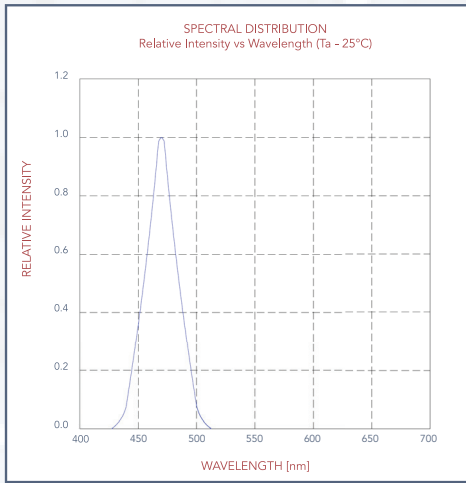

REFLOW PROFILE

- Soldering Condition

Recommended Soldering
After reflow soldering rapid cooling should be avoided

REFLOW SOLDERING		HAND SOLDERING	
Pre-Heat	160°C ~ 180°C	Temperature	300°C
Pre-Heat Time	120 Seconds Max.	Soldering Time	3 Second Max - One Time Only
Peak Temperature	260°C Max		
Soldering Time	10 Seconds Max		
Condition	Refer to Temperature		

- Temperature - profile (surface of circuit board)

Use the following conditions shown in the figure

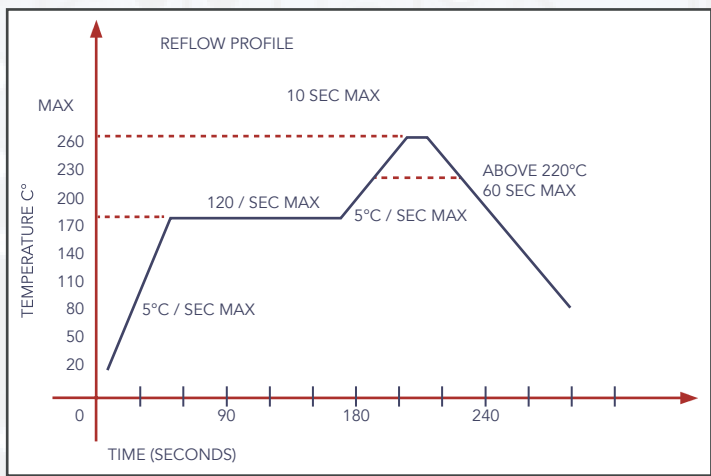

- Recommend Pad Design (Units: mm)

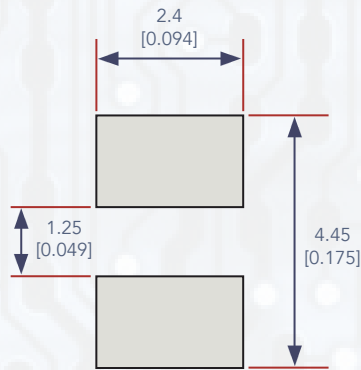

Reflow soldering should not be done more than two times
When soldering, do not put stress on the LEDs during heating

- Soldering Iron

When hand soldering, keep the temperature of the iron under 300°C, and at that temperature keep the time under 3 sec.
The hand soldering should be done only a time
The basic spec is ≤5 sec. when the temperature of 260°C, do not contact the resin when hand soldering.

- Rework

Customer must finish rework within 5 sec under 260°C
The head of iron can not touch the resin
Twin-head type is preferred

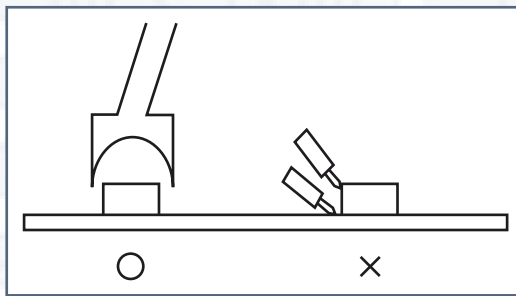

- CAUTIONS

The encapsulated material of the LEDs is silicone. Therefore the LEDs have a soft surface on the top of package. The pressure to the top surface will influence to the reliability of the LEDs. Precautions should be taken to avoid the strong pressure on the encapsulated part. So when using the picking up nozzle, the pressure on the silicone resin should be proper.

RELIABILITY

- TEST ITEMS AND RESULTS

TYPE	TEST ITEM	REF STANDARD	TEST CONDITIONS	NOTE	NUMBER OF DAMAGED
Environmental Sequence	Resistance to Soldering Heat (Reflow Soldering)	JESD22 - B106	Tsld - 260°C, 10 sec	2 times	0/22
	Temperature Cycle	JESD22 - A104	-40°C 30 min ↑↓ 5 min 100°C 30 min	300 cycle	0/22
	Thermal Shock	JESD22 - A106	-40°C 15min ↑↓ 100°C 15 min	300 cycle	0/22
	High Temperature Storage	JESD22 - A103	T _a - 100°C	1000 hrs	0/22
	Low Temperature Storage	JESD22 - A119	T _a - 40°C	1000 hrs	0/22
Operation Sequence	Life Test	JESD22 - A108	T _a - 25°C I _f - 20mA	1000 hrs	0/22
	High Humidity Heat Life Test	JESD22 - A101	60°C RH-90% I _f - 20mA	1000 hrs	0/22

- CRITERIA FOR JUDGING THE DAMAGE

ITEM	SYMBOL	TEST CONDITIONS	CRITERIA FOR JUDGEMENT	
			MIN.	MAX.
Forward Voltage	VF	IF- 20mA	-	U.S.L *) x 1.1
Reverse Current	IR	VR - 5V	-	U.S.L*) x 2.0
Luminous Intensity	IV	IF - 20mA	L.S.L**) x 0.7	-

- U.S.L.: Upper Standard Level
- L.S.L.: Lower Standard Level

PACKAGING SPECIFICATIONS

- Feeding Direction

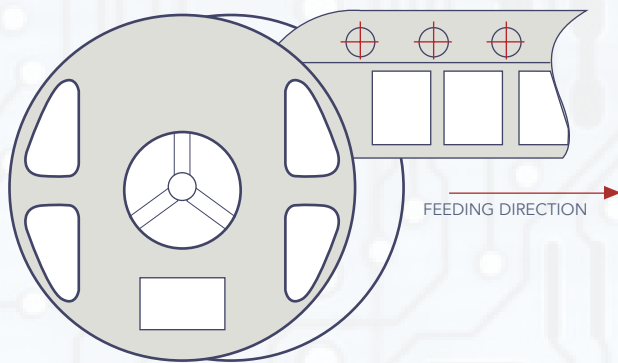

- Dimensions of Reel (Unit: mm)

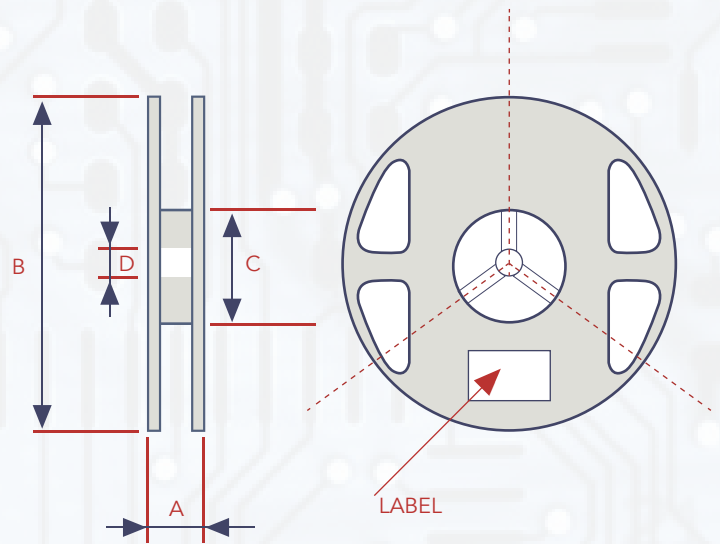

A	8.0 ± 0.1mm
B	178 ± 1mm
C	60 ± 1mm
D	13.0 ± 0.5mm



PACKAGING SPECIFICATIONS

- Dimensions of Tape (Unit: mm)

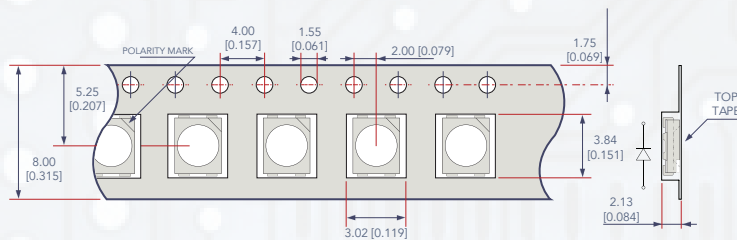

- Arrangement of Tape

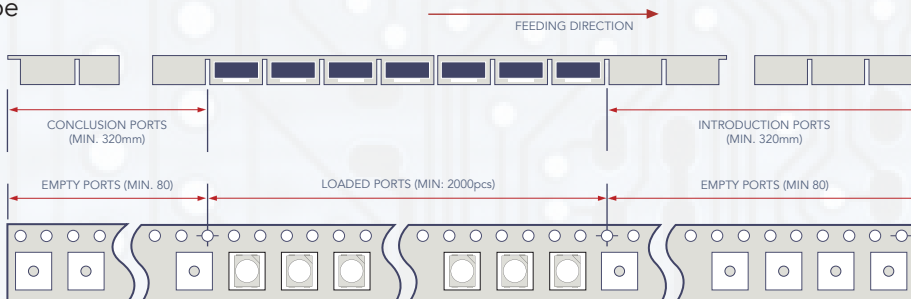

NOTE: Empty component pockets are sealed with top cover tape
 The maximum number of missing lamps is two:
 The cathode is oriented towards the tape sprocket hole in accordance with ANSI/EIA RS-481 specifications.
 2,000 pcs / Reel

PACKAGING SPECIFICATIONS

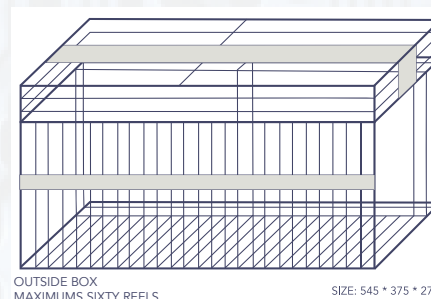
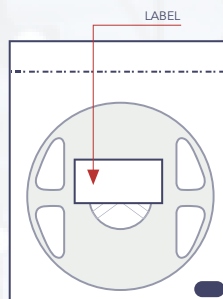
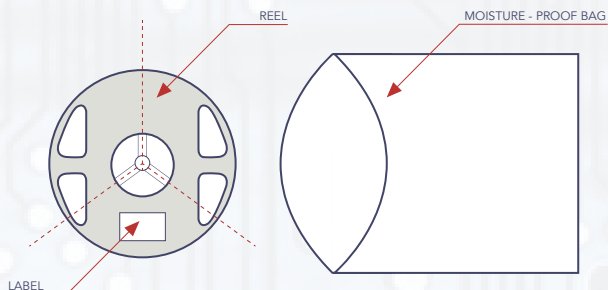

- Label

- Cautions

- Packaging Specification

- Reeled products (numbers of products are 2,000 pcs) packed in a seal off moisture-proof bag along with a desiccant one by one, Eighty moisture-proof bag of maximums are put the outside box (size: about 545mm x about 375mm x about 275mm) Together with buffer material, and it is packed. (Pare No., Lot No., quantity should appear on the label on the moisture-proof bag, part No. And quantity should appear on the label on the cardboard box.) The number of the loading steps of outside box (cardboard box) has two steps.

- Storage Conditions

- **Before Opening the Packaging** - The LEDs should be kept at 30°C or less and 70% RH or less. The LEDs should be used within a year. When storing the LEDs, moisture proof packaging with absorbant material is recommended.

- **After Opening the Package** - The LEDs should be kept at 30°C or less and 50% RH or less. If unused LEDs remain, they should be stored in moisture proof packages, such as sealed containers with packages of moisture absorbent material (silica gel). It is also recommended to return the LEDs to the original moisture proof bag and to reseal the moisture proof bag again.

GMC 21X5R475K50NT

2065112

ea Date Code 2132

Cal-Chip
Electronics Inc.