

CHIP COMMON MODE CHOKE

- CMH SERIES -

FEATURES

- Small chip inductor with ferrite core and two line types wire wound
- Highly effective in noise suppression High common-mode impedance at noise band and low differential-mode impedance at signal band
- Low differential-mode impedance with high coupling factor. There is almost no distortion on high-speed signal.
- Operating temperature -40°C~85°C



APPLICATIONS

- EMI Radiation Noise Suppression for ANY Electronic Device
- USB Line for Personal Computers and Peripheral
- IEEE 1394 Line for Personal Computers, DVC, STB
- LCD Panels. Low-Voltage Differential Signal (LVDS)

CONSTRUCTION

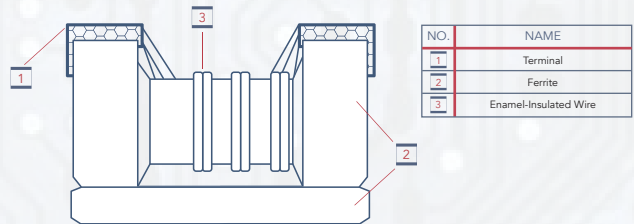

EQUIVALENT CIRCUIT

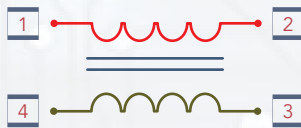

DIMENSIONS

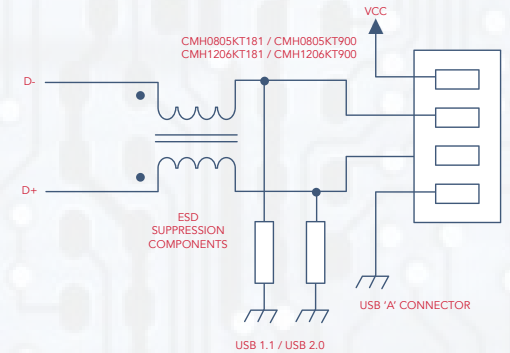
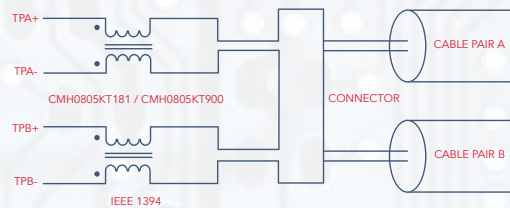
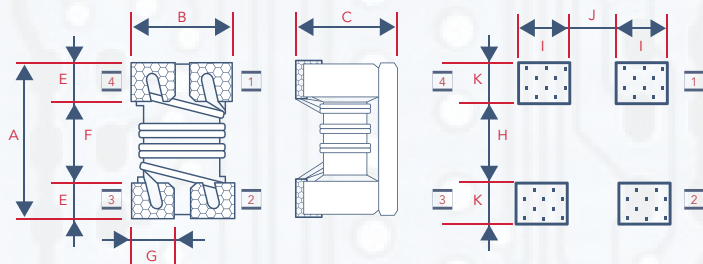

TYPE	SIZE (INCH)	A	B	C	E	F	G	H	I	J	K	WEIGHT (G) (1000pcs)
CMH05	0805	2.0±0.2	1.2±0.2	1.2±0.2	0.45	1.2	0.4	0.8	0.4	0.4	0.90	19
CMH06	1206	3.2±0.2	1.6±0.2	1.8±0.2	0.60	2.0	0.6	1.6	0.6	0.4	1.05	53.3

UNIT=mm

PART NUMBERING

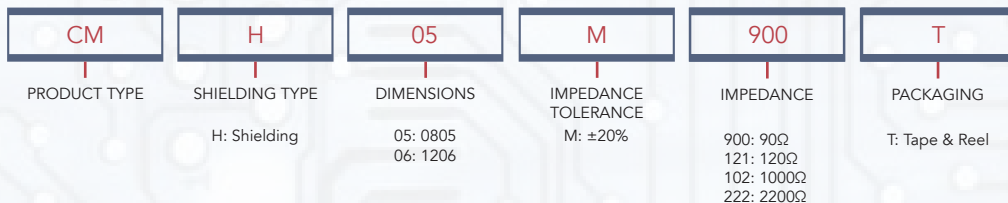

ELECTRICAL CHARACTERISTICS

CMH05 / STANDARD TYPE

IMPEDANCE (Ω)	TOLERANCE	TEST CONDITION (MHz)	DCR (Ω) MAX.	IDC (mA) MAX.	RATED VOLTAGE V _{dc} (V)	WITHSTANDING VOLTAGE V _{dc} (V)	INSULATION RESISTANCE (MΩ) MIN.
30	±20%	100	0.20	450	50	125	10
67	±20%	100	0.25	400	50	125	10
90	±20%	100	0.35	330	50	125	10
120	±20%	100	0.30	370	50	125	10
160	±20%	100	0.35	330	50	125	10
180	±20%	100	0.35	330	50	125	10
200	±20%	100	0.35	330	50	125	10
220	±20%	100	0.35	330	50	125	10
260	±20%	100	0.40	300	50	125	10
360	±20%	100	0.40	280	50	125	10
370	±20%	100	0.40	280	50	125	10

CMH06 / STANDARD TYPE

IMPEDANCE (Ω)	TOLERANCE	TEST CONDITION (MHz)	DCR (Ω) MAX.	IDC (mA) MAX.	RATED VOLTAGE V _{dc} (V)	WITHSTANDING VOLTAGE V _{dc} (V)	INSULATION RESISTANCE (MΩ) MIN.
90	±20%	100	0.30	370	50	125	10
120	±20%	100	0.30	370	50	125	10
160	±20%	100	0.40	340	50	125	10
260	±20%	100	0.50	310	50	125	10
600	±20%	100	0.80	260	50	125	10
1000	±20%	100	1.00	230	50	125	10
2200	±20%	100	1.20	200	50	125	10

CHARACTERISTICS (IMPEDANCE VS. FREQUENCY) - CMH05

CMH05M300T

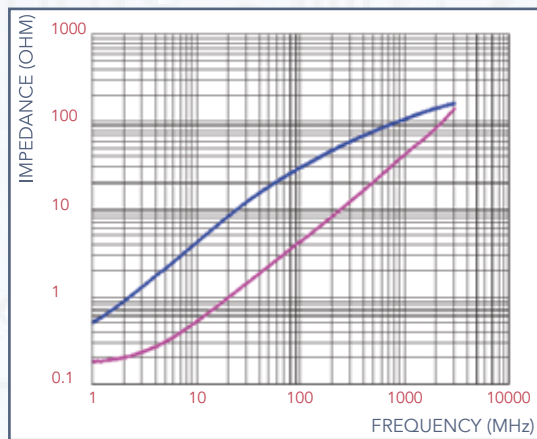

CMH05M670T

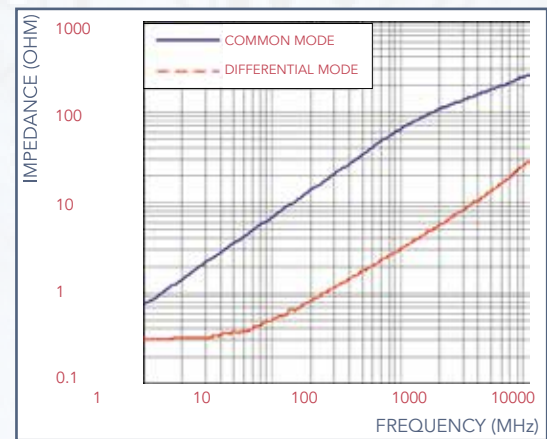

CHARACTERISTICS (IMPEDANCE VS. FREQUENCY) - CMH05

CMH05M900T

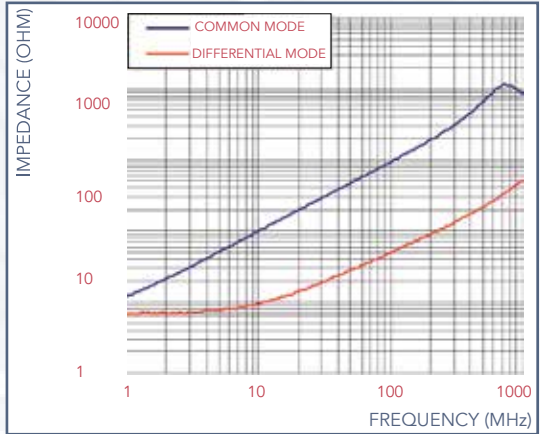

CMH05M121T

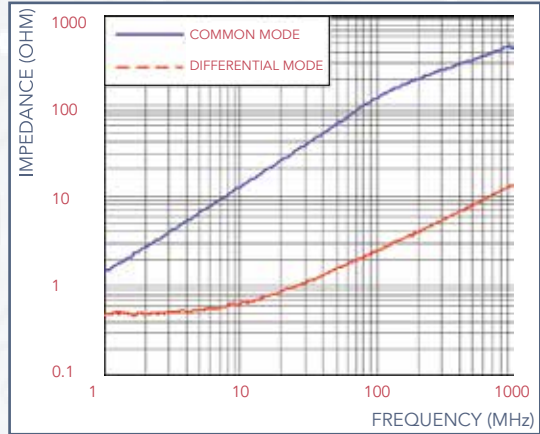

CMH05M161T

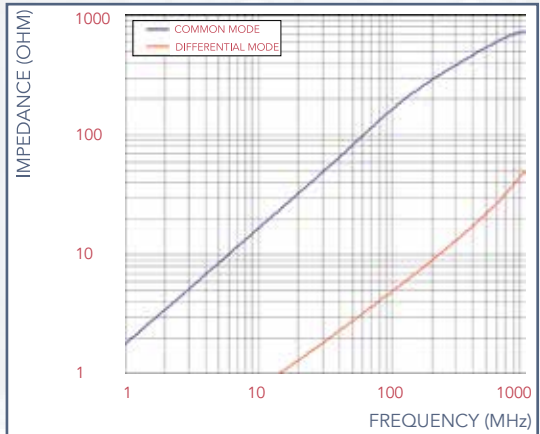

CMH05M181T

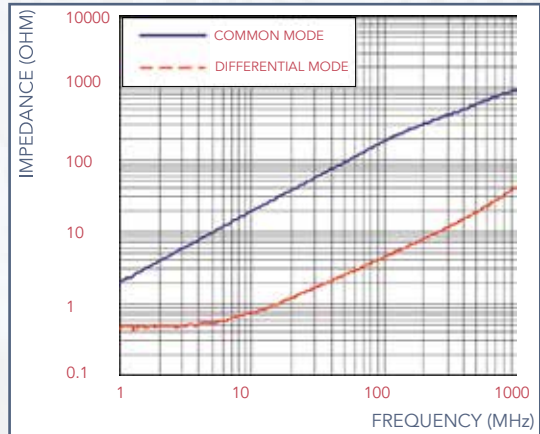

CMH05M201T

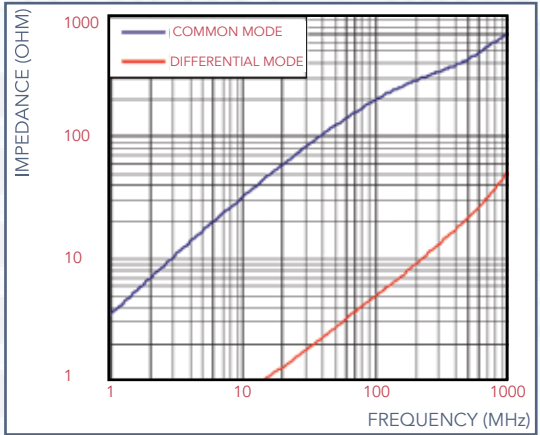

CMH05M221T

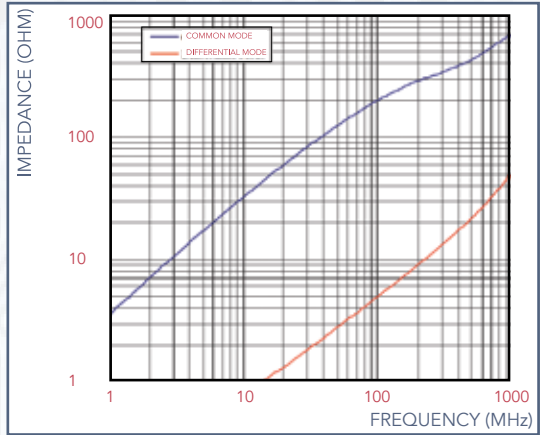



CHARACTERISTICS (IMPEDANCE VS. FREQUENCY) - CMH05 & CMH06

CMH05M261T

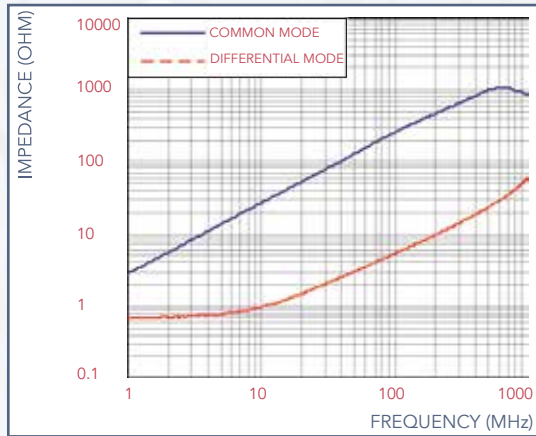

CMH05M361T

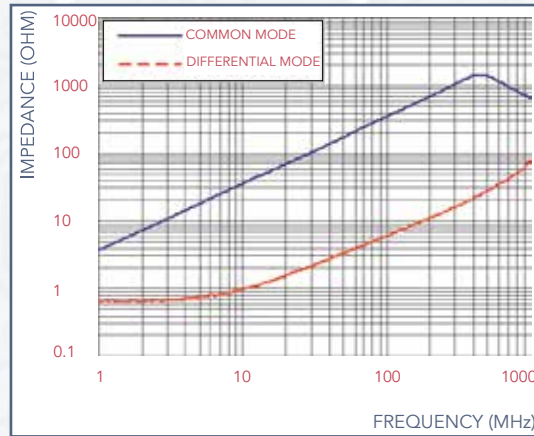

CMH05M371T

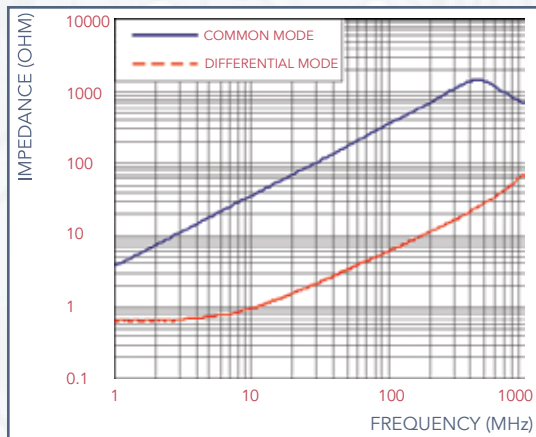

CMH06M900T

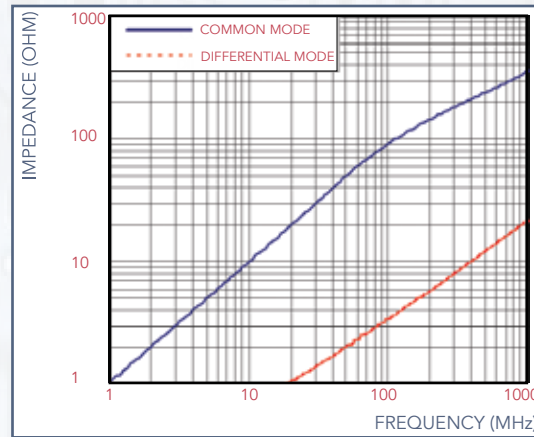

CMH06M221T

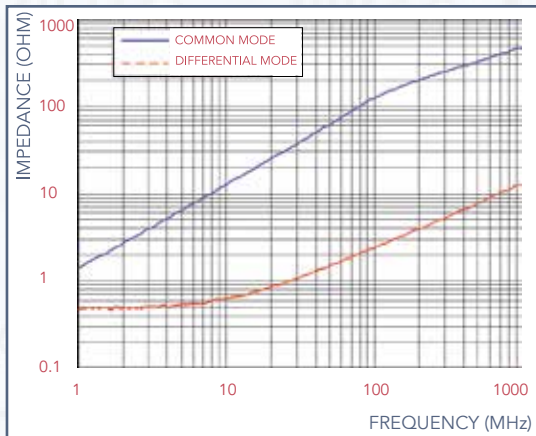

CMH06M161T

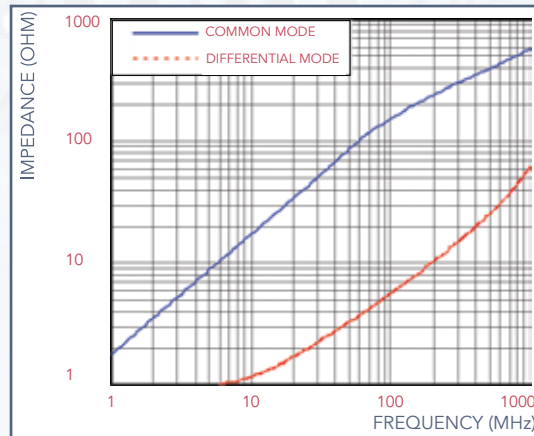

CHARACTERISTICS (IMPEDANCE VS. FREQUENCY) - CMH06

CMH06M261T

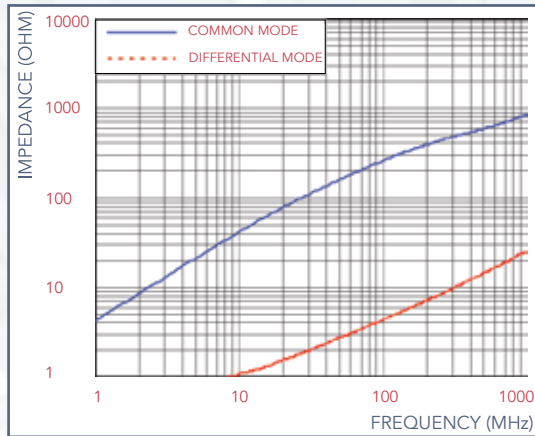

CMH06M601T

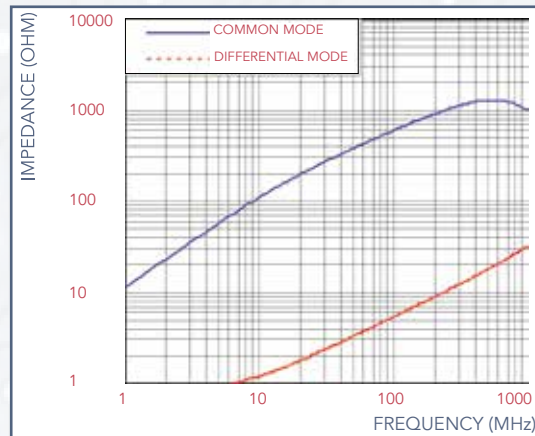

CMH06M102T

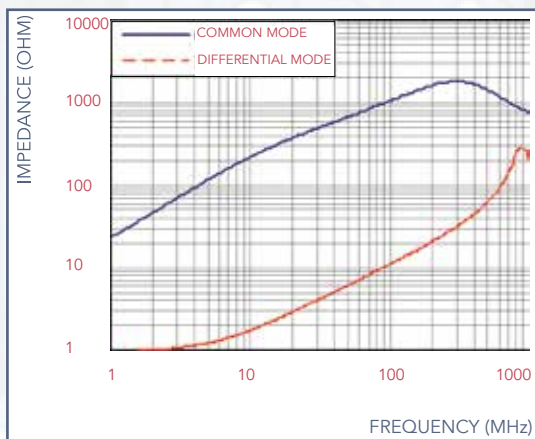

CMH06M222T

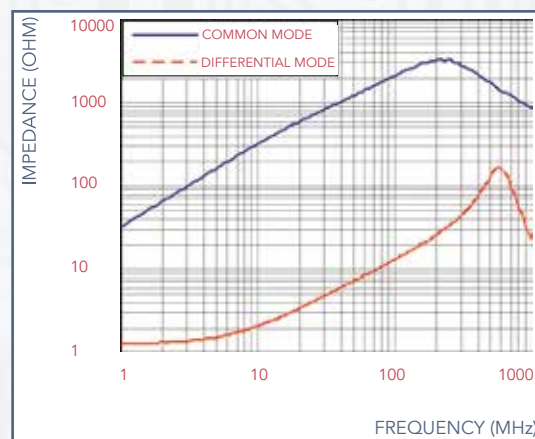

ENVIRONMENTAL CHARACTERISTICS

ELECTRICAL PERFORMANCE TEST

ITEMS	REQUIREMENT	TEST CONDITIONS / TEST METHODS
IMPEDANCE	- Refer to standard electrical characteristic spec. - Component should not be damaged	- LCR Meter HP 4291B
DC RESISTANC DCR		- Micro-Ohm meter (GOM-801G)
WITHSTAND VOLTAGE (VDC)		- Test Voltage: 2.5 Times Rated Voltage - Time: 60 seconds - Charge Current: 0.5mA
RATED VOLTAGE (VDC)		- Test Voltage: Rated Voltage - Testing Time: 1 to 5 seconds - Change Current 1mA
INSULATION RESISTANCE (I.R.)		- Charge Current: 1 minute - 10M ohm min.

MECHANICAL PERFORMANCE TEST

ITEMS	REQUIREMENT	TEST CONDITIONS / TEST METHODS
COMPONENT ADHESION (PUSH TEST)	- Base: 0805 \geq 2 Lbs - Cover: 0805 \geq 1 Lbs - Base: 1206 \geq 4 Lbs - Cover: 1206 \geq 2 Lbs	- The component should be soldered (232°C± for 10 Sec.) to tinned copper substrate. - Applied force guage to the side of component. It must withstand force of 2 or 4 pounds without failure of the component.
DROP	- Component should not be damaged	- Dropping chip by each side and corner. Drop 10 times in total - Drop height: 100 cm - Drop Weight: 125 g
SOLDERABILITY	- The terminal should at least be 90% covered with solder	- The component shall e dipped in a melted solder bath at 245 ±5 for seconds
VIBRATION TEST (LOW FREQUENCY)	- Component should not be damaged	- 1 - Amplitude: 1.5 m/m - 2 - Frequency: 10-55-10Hz (1 min.) - 3 - Direction: X, Y, Z - 4 - Duration: 2 Hrs / X, Y, Z

CLIMATIC TEST

ITEMS	REQUIREMENT	TEST CONDITIONS / TEST METHODS
LOW TEMPERATURE STORAGE	- Impedance Change: Within \pm 20% Without distinct damage in apperance	- 1 - Temp: -40 \pm 2°C - 2 - Time: 1000 \pm 48 Hours - 3 - Component should be tested after 1 hour at room temperature
THERMAL SHOCK		<p>- Total: 5 Cycles</p>
HIGH TEMPERATURE STORAGE		- 1 - Temp: 85 \pm 2°C - 2 - Time: 1000 \pm 48 Hours - 3 - Component should be tested after 1 hour at room temperature
HUMIDITY		- 1 - Temp: 40 \pm 2°C - 2 - R.H.: 90 ~ 95% - 3 - Time: 48 \pm 2 Hours
HIGH TEMPERATURE LOAD LIFE		- 1 - Temp: 85 \pm 2°C - 2 - Time: 96 \pm 12 Hours - 3 - Load: Allowed DC Current
VIBRATION TEST (LOW FREQUENCY)		- 1 - Temp: -40 \pm 2°C - 2 - Time: 96 \pm 12 Hours - 3 - Load: Allowed DC Current

■ Storage Temperature: 25±3°C; Humidity <80%RH



PACKAGING

- Packaging Quantity & Reel Specifications

TYPE	ØA	ØB	ØC	W	T	QUANTITY (EA)
CMH05	178±2.0	60±0.5	13±0.3	9±0.3	11.4±1.0	2000
CMH06	178±2.0	60±0.5	13±0.3	9±0.3	11.4±1.0	2000

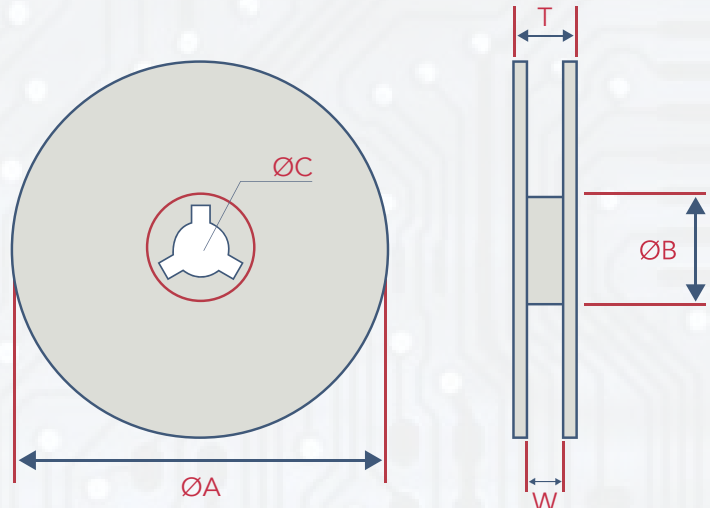

- Embossed Plastic Tape Specifications

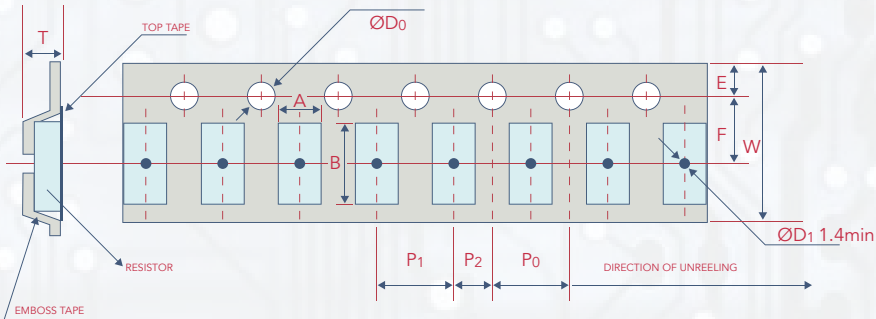

TYPE	A	B	W	E	F	P ₀	P ₁	P ₂	ØD ₀	T
CMH05	1.40±0.10	2.55±0.05	8.0±0.20	1.75±0.10	3.5±0.10	4.00±0.10	4.00±0.10	2.00±0.10	1.50±0.10	1.35±0.10
CMH06	1.90±0.10	3.50±0.05	8.0±0.20	1.75±0.10	3.5±0.10	4.00±0.10	4.00±0.10	2.00±0.10	1.50±0.10	2.10±0.10

- Leader / Tape

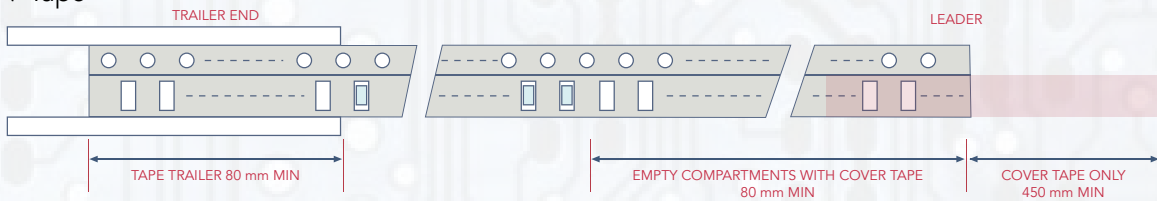

- Peel-Off Force

The force for tearing off cover tape is 0.05~0.69 (N) in the arrow direction at the following conditions:

- Temperature: 5~ 35°C
- Humidity: 45~85%
- Atmospheric pressure: 860 ~ 1060hpa

