

# MULTILAYER CHIP BEADS

## - FB SERIES -

### FEATURES

- Effective EMI protection
- Low DC resistance
- High soldering heat resistance
- Multiple size availability



### APPLICATIONS

- Computers and Peripheral Equipment
- VCRS, Television, Pagers
- Cellular Phones
- Digital Communication Equipment
- Various Electronics Equipments
- Circuit Where a Stable Ground is Unavailable

### EXTERNAL DIMENSIONS & CONSTRUCTION

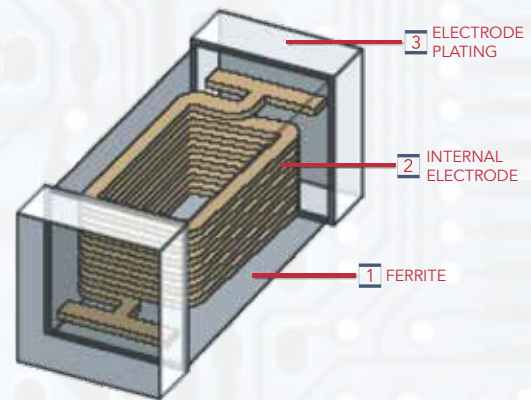
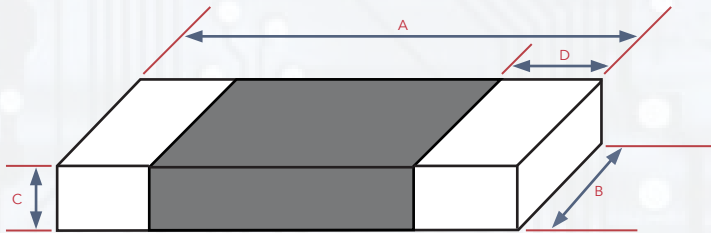

TYPE	SIZE (INCH)	A (MM)	B (MM)	C (MM)	D (MM)	WEIGHT (g) (1000pcs)
FB060303	0201	0.6 ± 0.3	0.30 ± 0.03	0.30 ± 0.03	0.1 ~ 0.2	1.1
FB100505	0402	1.0 ± 0.10	0.50 ± 0.10	0.5 ± 0.10	0.1 ~ 0.35	2.6
FB160808	0603	1.6 ± 0.20	0.80 ± 0.15	0.8 ± 0.15	0.1 ~ 0.6	6.2
FB201209	0805	2.0 ± 0.20	1.25 ± 0.20	0.9 ± 0.20	0.2 ~ 0.8	10
FB321611	1206	3.2 ± 0.20	1.60 ± 0.20	1.1 ± 0.20	0.2 ~ 1.0	30
FB321616	1206	3.2 ± 0.20	1.50 ± 0.20	1.6 ± 0.20	0.5 ~ 0.3	35
FB322513	1210	3.2 ± 0.20	2.50 ± 0.20	1.3 ± 0.20	0.2 ~ 1.0	54
FB451616	1806	4.5 ± 0.25	1.60 ± 0.20	1.6 ± 0.20	0.2 ~ 1.0	60
FB453215	1812	4.5 ± 0.25	3.20 ± 0.20	1.5 ± 0.20	0.2 ~ 1.0	62

### PART NUMBERING

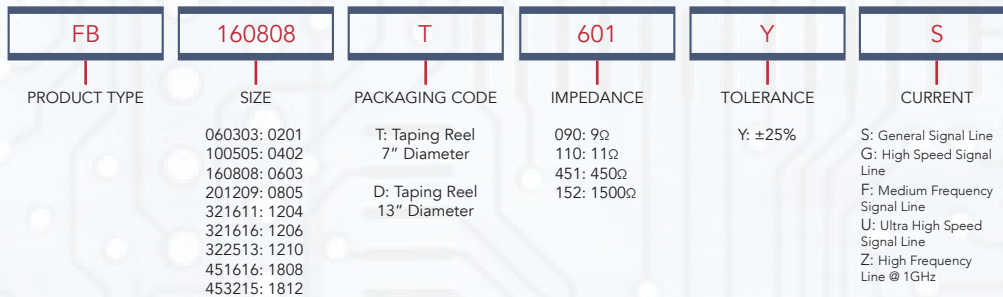



## STANDARD ELECTRICAL SPECIFICATIONS (FOR GENERAL SIGNAL LINE)

## FB060303 (0201)

PART NUMBER	IMPEDANCE ( $\Omega$ )	TOLERANCE	TEST FREQUENCY (MHz)	DC RESISTANCE $\Omega$ (MAX)	RATED CURRENT mA (MAX) at 85°C
FB060303T-100Y-S	10	$\pm 25\%$	100	0.10	500
FB060303T-110Y-S	11	$\pm 25\%$	100	0.10	500
FB060303T-220Y-S	22	$\pm 25\%$	100	0.065	500
FB060303T-250Y-S	25	$\pm 25\%$	100	0.30	300
FB060303T-300Y-S	30	$\pm 25\%$	100	0.30	300
FB060303T-330Y-S	33	$\pm 25\%$	100	0.30	300
FB060303T-400Y-S	40	$\pm 25\%$	100	0.30	300
FB060303T-500Y-S	50	$\pm 25\%$	100	0.30	300
FB060303T-600Y-S	60	$\pm 25\%$	100	0.35	300
FB060303T-700Y-S	70	$\pm 25\%$	100	0.35	300
FB060303T-800Y-S	80	$\pm 25\%$	100	0.35	300
FB060303T-101Y-S	100	$\pm 25\%$	100	0.40	200
FB060303T-121Y-S	120	$\pm 25\%$	100	0.45	200
FB060303T-151Y-S	150	$\pm 25\%$	100	0.50	200
FB060303T-221Y-S	220	$\pm 25\%$	100	0.75	200
FB060303T-241Y-S	240	$\pm 25\%$	100	0.80	200
FB060303T-301Y-S	300	$\pm 25\%$	100	0.90	150
FB060303T-331Y-S	330	$\pm 25\%$	100	0.90	150
FB060303T-471Y-S	470	$\pm 25\%$	100	1.50	100
FB060303T-601Y-S	600	$\pm 25\%$	100	1.20	100
FB060303T-102Y-S	1000	$\pm 25\%$	100	1.15	200

## FB100505 (0402)

PART NUMBER	IMPEDANCE ( $\Omega$ )	TOLERANCE	TEST FREQUENCY (MHz)	DC RESISTANCE $\Omega$ (MAX)	RATED CURRENT mA (MAX) at 85°C
FB100505T-100Y-S	10	$\pm 25\%$	100	0.05	500
FB100505T-200Y-S	20	$\pm 25\%$	100	0.10	300
FB100505T-220Y-S	22	$\pm 25\%$	100	0.35	300
FB100505T-300Y-S	30	$\pm 25\%$	100	0.20	300
FB100505T-300Y-S-1	30	$\pm 25\%$	100	0.20	500
FB100505T-330Y-S	33	$\pm 25\%$	100	0.40	300
FB100505T-400Y-S	40	$\pm 25\%$	100	0.20	300
FB100505T-470Y-S	47	$\pm 25\%$	100	0.40	300
FB100505T-560Y-S	56	$\pm 25\%$	100	0.30	400
FB100505T-600Y-S	60	$\pm 25\%$	100	0.40	200
FB100505T-600Y-S-1	60	$\pm 25\%$	100	0.40	300



**STANDARD ELECTRICAL SPECIFICATIONS (FOR GENERAL SIGNAL LINE)**

FB100505 (0402) (CONT.)

PART NUMBER	IMPEDANCE ( $\Omega$ )	TOLERANCE	TEST FREQUENCY (MHz)	DC RESISTANCE $\Omega$ (MAX)	RATED CURRENT mA (MAX) at 85°C
FB100505T-680Y-S	68	$\pm 25\%$	100	0.15	500
FB100505T-700Y-S	70	$\pm 25\%$	100	0.40	200
FB100505T-700Y-S-1	70	$\pm 25\%$	100	0.25	500
FB100505T-750Y-S	75	$\pm 25\%$	100	0.40	300
FB100505T-800Y-S	80	$\pm 25\%$	100	0.40	200
FB100505T-101Y-S	100	$\pm 25\%$	100	0.45	200
FB100505T-121Y-S	120	$\pm 25\%$	100	0.50	200
FB100505T-121Y-S-1	120	$\pm 25\%$	100	0.20	500
FB100505T-121Y-S-2	120	$\pm 25\%$	100	0.30	800
FB100505T-151Y-S	150	$\pm 25\%$	100	0.60	200
FB100505T-181Y-S	180	$\pm 25\%$	100	0.65	100
FB100505T-221Y-S	220	$\pm 25\%$	100	0.70	100
FB100505T-221Y-S-1	220	$\pm 25\%$	100	0.35	300
FB100505T-221Y-S-2	220	$\pm 25\%$	100	0.30	800
FB100505T-241Y-S	240	$\pm 25\%$	100	0.30	500
FB100505T-301Y-S	300	$\pm 25\%$	100	0.75	100
FB100505T-301Y-S-1	300	$\pm 25\%$	100	0.45	400
FB100505T-331Y-S	330	$\pm 25\%$	100	0.75	100
FB100505T-331Y-S-1	330	$\pm 25\%$	100	0.20	800
FB100505T-331Y-S-2	330	$\pm 25\%$	100	0.28	700
FB100505T-431Y-S	430	$\pm 25\%$	100	0.50	350
FB100505T-471Y-S	470	$\pm 25\%$	100	0.90	100
FB100505T-471Y-S-1	470	$\pm 25\%$	100	0.60	300
FB100505T-501Y-S	500	$\pm 25\%$	100	1.00	100
FB100505T-601Y-S	600	$\pm 25\%$	100	1.10	50
FB100505T-601Y-S-1	600	$\pm 25\%$	100	0.60	300
FB100505T-601Y-S-2	600	$\pm 25\%$	100	0.80	600
FB100505T-102Y-S	1000	$\pm 25\%$	100	1.50	50
FB100505T-102Y-S-1	1000	$\pm 25\%$	100	0.80	250
FB100505T-102Y-S-2	1000	$\pm 25\%$	100	0.58	300
FB100505T-102Y-S-3	1000	$\pm 25\%$	100	0.49	350
FB100505T-152Y-S	1500	$\pm 25\%$	100	0.80	250
FB100505T-182Y-S	1800	$\pm 25\%$	100	0.80	250



## STANDARD ELECTRICAL SPECIFICATIONS (FOR GENERAL SIGNAL LINE)

FB160808 (0603)

PART NUMBER	IMPEDANCE ( $\Omega$ )	TOLERANCE	TEST FREQUENCY (MHz)	DC RESISTANCE $\Omega$ (MAX)	RATED CURRENT mA (MAX) at 85°C
FB160808T-050Y-S-1	5	$\pm 25\%$	100	0.08	700
FB160808T-070Y-S-1	7	$\pm 25\%$	100	0.10	900
FB160808T-100Y-S	10	$\pm 25\%$	100	0.05	600
FB160808T-100Y-S-1	10	$\pm 25\%$	100	0.10	900
FB160808T-190Y-S	19	$\pm 25\%$	100	0.10	400
FB160808T-200Y-S	20	$\pm 25\%$	100	0.25	500
FB160808T-300Y-S	30	$\pm 25\%$	100	0.20	500
FB160808T-300Y-S-1	30	$\pm 25\%$	100	0.08	600
FB160808T-300Y-S-2	30	$\pm 25\%$	100	0.20	700
FB160808T-310Y-S	300	$\pm 25\%$	100	0.10	400
FB160808T-520Y-S	52	$\pm 25\%$	100	0.15	400
FB160808T-600Y-S	60	$\pm 25\%$	100	0.15	400
FB160808T-600Y-S-1	60	$\pm 25\%$	100	0.10	500
FB160808T-600Y-S-2	60	$\pm 25\%$	100	0.10	600
FB160808T-680Y-S-1	68	$\pm 25\%$	100	0.10	700
FB160808T-700Y-S	70	$\pm 25\%$	100	0.15	400
FB160808T-750Y-S	75	$\pm 25\%$	100	0.15	400
FB160808T-750Y-S-1	75	$\pm 25\%$	100	0.35	500
FB160808T-800Y-S	80	$\pm 25\%$	100	0.15	400
FB160808T-800Y-S-1	80	$\pm 25\%$	100	0.10	600
FB160808T-800Y-S-2	80	$\pm 25\%$	100	0.20	700
FB160808T-101Y-S	100	$\pm 25\%$	100	0.15	400
FB160808T-121Y-S	120	$\pm 25\%$	100	0.15	400
FB160808T-121Y-S-1	120	$\pm 25\%$	100	0.10	800
FB160808T-151Y-S	150	$\pm 25\%$	100	0.15	400
FB160808T-181Y-S	180	$\pm 25\%$	100	0.20	400
FB160808T-201Y-S	200	$\pm 25\%$	100	0.20	400



**STANDARD ELECTRICAL SPECIFICATIONS (FOR GENERAL SIGNAL LINE)**

FB160808 (0603) (CONT.)

PART NUMBER	IMPEDANCE (Ω)	TOLERANCE	TEST FREQUENCY (MHz)	DC RESISTANCE Ω (MAX)	RATED CURRENT mA (MAX) at 85°C
FB160808T-221Y-S	220	±25%	100	0.20	400
FB160808T-221Y-S-1	220	±25%	100	0.30	550
FB160808T-241Y-S	240	±25%	100	0.17	500
FB160808T-301Y-S	300	±25%	100	0.30	400
FB160808T-301Y-S-1	300	±25%	100	0.35	450
FB160808T-301Y-S-2	300	±25%	100	0.35	500
FB160808T-331Y-S	330	±25%	100	0.30	500
FB160808T-401Y-S	400	±25%	100	0.30	400
FB160808T-401Y-S-1	400	±25%	100	0.20	500
FB160808T-421Y-S	420	±25%	100	0.30	400
FB160808T-451Y-S	450	±25%	100	0.30	400
FB160808T-471Y-S	470	±25%	100	0.45	400
FB160808T-471Y-S-1	470	±25%	100	0.45	500
FB160808T-501Y-S	500	±25%	100	0.35	400
FB160808T-601Y-S	600	±25%	100	0.40	450
FB160808T-601Y-S-1	600	±25%	100	0.50	500
FB160808T-751Y-S	750	±25%	100	0.15	400
FB160808T-102Y-S	1000	±25%	100	0.55	300
FB160808T-102Y-S-1	1000	±25%	100	0.25	800
FB160808T-102Y-S-2	1000	±25%	100	0.70	500
FB160808T-152Y-S	1500	±25%	100	0.60	200
FB160808T-152Y-S-1	1500	±25%	100	1.00	300
FB160808T-182Y-S	1800	±25%	100	0.70	100
FB160808T-182Y-S-1	1800	±25%	100	1.00	200
FB160808T-202Y-S	2000	±25%	100	1.00	100
FB160808T-252Y-S	2500	±25%	100	0.70	100
FB160808T-252Y-S-1	2500	±25%	200	0.70	100
FB160808T-202Y-S	2000	±25%	100	1.00	100
FB160808T-252Y-S	2500	±25%	100	0.70	100
FB160808T-252Y-S-1	2500	±25%	200	0.70	100



## STANDARD ELECTRICAL SPECIFICATIONS (FOR GENERAL SIGNAL LINE)

FB201209 (0805)

PART NUMBER	IMPEDANCE ( $\Omega$ )	TOLERANCE	TEST FREQUENCY (MHz)	DC RESISTANCE $\Omega$ (MAX)	RATED CURRENT mA (MAX) at 85°C
FB201209T-050Y-S	5	$\pm 25\%$	100	0.07	500
FB201209T-070Y-S	7	$\pm 25\%$	100	0.07	500
FB201209T-100Y-S	10	$\pm 25\%$	100	0.07	500
FB201209T-110Y-S	11	$\pm 25\%$	100	0.10	500
FB201209T-130Y-S	13	$\pm 25\%$	100	0.08	500
FB201209T-170Y-S	17	$\pm 25\%$	100	0.10	300
FB201209T-260Y-S	26	$\pm 25\%$	100	0.10	300
FB201209T-300Y-S	30	$\pm 25\%$	100	0.10	300
FB201209T-300Y-S-1	30	$\pm 25\%$	100	0.05	800
FB201209T-310Y-S	31	$\pm 25\%$	100	0.10	300
FB201209T-320Y-S	32	$\pm 25\%$	100	0.15	300
FB201209T-330Y-S	33	$\pm 25\%$	100	0.10	300
FB201209T-400Y-S	40	$\pm 25\%$	100	0.05	800
FB201209T-520Y-S	52	$\pm 25\%$	100	0.15	300
FB201209T-600Y-S	60	$\pm 25\%$	100	0.15	300
FB201209T-600Y-S-1	60	$\pm 25\%$	100	0.15	800
FB201209T-600Y-S-2	60	$\pm 25\%$	100	0.10	900
FB201209T-700Y-S	70	$\pm 25\%$	100	0.20	300
FB201209T-750Y-S	75	$\pm 25\%$	100	0.20	300
FB201209T-800Y-S	80	$\pm 25\%$	100	0.15	300
FB201209T-800Y-S-1	80	$\pm 25\%$	100	0.15	800
FB201209T-101Y-S	100	$\pm 25\%$	100	0.20	300
FB201209T-121Y-S	120	$\pm 25\%$	100	0.20	300
FB201209T-121Y-S-1	120	$\pm 25\%$	100	0.15	800
FB201209T-151Y-S	150	$\pm 25\%$	100	0.20	300





## STANDARD ELECTRICAL SPECIFICATIONS (FOR GENERAL SIGNAL LINE)

FB201209 (0805)

PART NUMBER	IMPEDANCE ( $\Omega$ )	TOLERANCE	TEST FREQUENCY (MHz)	DC RESISTANCE $\Omega$ (MAX)	RATED CURRENT mA (MAX) at 85°C
FB201209T-151Y-S-1	150	$\pm 25\%$	100	0.10	800
FB201209T-201Y-S	200	$\pm 25\%$	100	0.25	300
FB201209T-221Y-S	220	$\pm 25\%$	100	0.25	300
FB201209T-221Y-S-1	220	$\pm 25\%$	100	0.20	500
FB201209T-221Y-S-2	220	$\pm 25\%$	100	0.30	750
FB201209T-301Y-S	300	$\pm 25\%$	100	0.25	300
FB201209T-301Y-S-1	300	$\pm 25\%$	100	0.20	500
FB201209T-301Y-S-2	300	$\pm 25\%$	100	0.30	700
FB201209T-331Y-S	330	$\pm 25\%$	100	0.25	300
FB201209T-401Y-S	400	$\pm 25\%$	100	0.30	300
FB201209T-471Y-S	470	$\pm 25\%$	100	0.18	700
FB201209T-531Y-S	530	$\pm 25\%$	100	0.35	300
FB201209T-601Y-S	600	$\pm 25\%$	100	0.25	200
FB201209T-601Y-S-1	600	$\pm 25\%$	100	0.30	500
FB201209T-751Y-S	750	$\pm 25\%$	100	0.20	300
FB201209T-102Y-S	1000	$\pm 25\%$	100	0.45	300
FB201209T-102Y-S-1	1000	$\pm 25\%$	100	0.45	400
FB201209T-122Y-S	1200	$\pm 25\%$	100	0.40	200
FB201209T-152Y-S	1500	$\pm 25\%$	100	0.70	300
FB201209T-182Y-S	1800	$\pm 25\%$	100	0.40	200
FB201209T-202Y-S	2000	$\pm 25\%$	100	0.50	500
FB201209T-222Y-S	2200	$\pm 25\%$	100	0.50	200
FB201209T-252Y-S	2500	$\pm 25\%$	100	0.60	200
FB201209T-272Y-S	2700	$\pm 25\%$	100	0.60	200



## STANDARD ELECTRICAL SPECIFICATIONS (FOR GENERAL SIGNAL LINE)

FB321611 (1206)

PART NUMBER	IMPEDANCE ( $\Omega$ )	TOLERANCE	TEST FREQUENCY (MHz)	DC RESISTANCE $\Omega$ (MAX)	RATED CURRENT mA (MAX) at 85°C
FB321611T-050Y-S	5	$\pm 25\%$	100	0.07	500
FB321611T-070Y-S	7	$\pm 25\%$	100	0.07	500
FB321611T-190Y-S	19	$\pm 25\%$	100	0.10	800
FB321611T-260Y-S	26	$\pm 25\%$	100	0.10	800
FB321611T-310Y-S	31	$\pm 25\%$	100	0.10	800
FB321611T-320Y-S	32	$\pm 25\%$	100	0.10	800
FB321611T-500Y-S	50	$\pm 25\%$	100	0.15	800
FB321611T-520Y-S	52	$\pm 25\%$	100	0.15	800
FB321611T-550Y-S	55	$\pm 25\%$	100	0.15	500
FB321611T-600Y-S	60	$\pm 25\%$	100	0.15	500
FB321611T-700Y-S	70	$\pm 25\%$	100	0.15	500
FB321611T-700Y-S-1	70	$\pm 25\%$	100	0.10	800
FB321611T-900Y-S	90	$\pm 25\%$	100	0.15	500
FB321611T-101Y-S	100	$\pm 25\%$	100	0.20	450
FB321611T-121Y-S	120	$\pm 25\%$	100	0.20	450
FB321611T-121Y-S-1	120	$\pm 25\%$	100	0.15	600
FB321611T-121Y-S-2	120	$\pm 25\%$	100	0.15	900
FB321611T-151Y-S	150	$\pm 25\%$	100	0.20	450
FB321611T-181Y-S	180	$\pm 25\%$	100	0.20	350
FB321611T-201Y-S	200	$\pm 25\%$	100	0.25	350
FB321611T-221Y-S	220	$\pm 25\%$	100	0.20	350
FB321611T-221Y-S-1	220	$\pm 25\%$	100	0.35	700
FB321611T-301Y-S	300	$\pm 25\%$	100	0.20	350
FB321611T-401Y-S	400	$\pm 25\%$	100	0.25	350
FB321611T-501Y-S	500	$\pm 25\%$	100	0.25	350
FB321611T-601Y-S	600	$\pm 25\%$	100	0.25	350
FB321611T-601Y-S-1	600	$\pm 25\%$	100	0.25	500
FB321611T-751Y-S	750	$\pm 25\%$	100	0.30	350
FB321611T-801Y-S	800	$\pm 25\%$	100	0.30	350
FB321611T-102Y-S	1000	$\pm 25\%$	100	0.35	350
FB321611T-102Y-S-1	1000	$\pm 25\%$	100	0.40	500
FB321611T-122Y-S	1200	$\pm 25\%$	100	0.35	350
FB321611T-122Y-S-1	1200	$\pm 25\%$	100	0.40	500
FB321611T-152Y-S	1500	$\pm 25\%$	100	0.40	350
FB321611T-152Y-S-1	1500	$\pm 25\%$	100	0.20	800
FB321611T-182Y-S	1800	$\pm 25\%$	100	0.40	350
FB321611T-202Y-S	2000	$\pm 25\%$	100	0.50	200







# STANDARD ELECTRICAL SPECIFICATIONS (FOR GENERAL SIGNAL LINE)

## FB321616 (1206)

PART NUMBER	IMPEDANCE (Ω)	TOLERANCE	TEST FREQUENCY (MHz)	DC RESISTANCE Ω (MAX)	RATED CURRENT mA (MAX) at 85°C
FB321616T-250Y-S	25	±25%	100	0.10	500
FB321616T-600Y-S	60	±25%	100	0.20	500
FB321616T-700Y-S	70	±25%	100	0.20	500

## FB322513 (1210)

PART NUMBER	IMPEDANCE (Ω)	TOLERANCE	TEST FREQUENCY (MHz)	DC RESISTANCE Ω (MAX)	RATED CURRENT mA (MAX) at 85°C
FB322513T-310Y-S	31	±25%	100	0.10	500
FB322513T-320Y-S	32	±25%	100	0.10	500
FB322513T-520Y-S	52	±25%	100	0.30	400
FB322513T-600Y-S	60	±25%	100	0.30	400
FB322513T-600Y-S-1	60	±25%	100	0.30	800
FB322513T-650Y-S	65	±25%	100	0.30	400
FB322513T-900Y-S	90	±25%	100	0.30	800
FB322513T-121Y-S	120	±25%	100	0.30	400
FB322513T-201Y-S	200	±25%	100	0.45	200

## FB451616 (1806)

PART NUMBER	IMPEDANCE (Ω)	TOLERANCE	TEST FREQUENCY (MHz)	DC RESISTANCE Ω (MAX)	RATED CURRENT mA (MAX) at 85°C
FB451616T-600Y-S	60	±25%	100	0.20	500
FB451616T-800Y-S	80	±25%	100	0.30	400
FB451616T-800Y-S-1	80	±25%	100	0.10	800
FB451616T-101Y-S	100	±25%	100	0.30	400
FB451616T-151Y-S	150	±25%	100	0.50	200
FB451616T-151Y-S-1	150	±25%	100	0.30	800
FB451616T-601Y-S	600	±25%	100	0.80	200

## FB453215 (1812)

PART NUMBER	IMPEDANCE (Ω)	TOLERANCE	TEST FREQUENCY (MHz)	DC RESISTANCE Ω (MAX)	RATED CURRENT mA (MAX) at 85°C
FB453215T-310Y-S	31	±25%	100	0.10	500
FB453215T-600Y-S	60	±25%	100	0.20	500
FB453215T-700Y-S	70	±25%	100	0.40	800
FB453215T-800Y-S	80	±25%	100	0.40	800
FB453215T-950Y-S	95	±25%	100	0.20	500
FB453215T-121Y-S	120	±25%	100	0.20	500
FB453215T-121Y-S-1	120	±25%	100	0.40	800
FB453215T-151Y-S	150	±25%	100	0.20	500
FB453215T-151Y-S-1	150	±25%	100	0.30	800
FB453215T-471Y-S	470	±25%	100	0.20	500



# ENVIRONMENTAL CHARACTERISTICS

## ELECTRICAL PERFORMANCE TEST

ITEM	SPECIFICATION	TEST METHODS
Impedance	Refer to standard electrical spec.	- HP4286A
DCR		- HP 4338 digital mili-ohm meter

## MECHANICAL PERFORMANCE TEST

ITEM	SPECIFICATION	TEST METHODS
Substrate Bending Test	<ul style="list-style-type: none"> <li>- Without deformation cases</li> <li>- Impedance: within <math>\pm 30\%</math> of initial value</li> <li>- DC Resistance shall be satisfied</li> </ul>	<ul style="list-style-type: none"> <li>- Test device shall be soldered on the substrate</li> <li>- Substrate Dimension: 100x40x0.8mm</li> <li>- Deflection: 3.0mm</li> <li>- Keeping Time: 10sec and then return</li> </ul>
Vibration	<ul style="list-style-type: none"> <li>- Appearance: No damage</li> <li>- Impedance: within <math>\pm 30\%</math> of initial value</li> <li>- DC Resistance shall be satisfied</li> </ul>	<ul style="list-style-type: none"> <li>- Test device shall be soldered on the substrate</li> <li>- Oscillation Frequency : 10 to 55 to 10Hz for 1min</li> <li>- Amplitude : 1.5mm(peak-peak)</li> <li>- Time : 2hrs for each axis (X,Y&amp;Z), total 6hrs</li> </ul>
Resistance to Soldering Heat	<ul style="list-style-type: none"> <li>- No visible damage</li> <li>- Electrical characteristics and mechanical characteristics shall be satisfied</li> </ul>	<ul style="list-style-type: none"> <li>- Solder temp: 265<math>\pm</math>5<math>^{\circ}</math>C</li> <li>- Immersion time: 6<math>\pm</math>1sec</li> <li>- Preheating: 100<math>^{\circ}</math>C to 150<math>^{\circ}</math>C, 1 minute</li> <li>- Measured after exposure in the room condition for 24hrs</li> <li>- Solder: Sn-3Ag-0.5Cu</li> </ul>
Solderability	<ul style="list-style-type: none"> <li>- 95% min. coverage of all metallized area</li> </ul>	<ul style="list-style-type: none"> <li>- Solder Temperature: 240<math>\pm</math>5<math>^{\circ}</math>C</li> <li>- Immersion Time: 3<math>\pm</math>1sec</li> <li>- Solder: Sn-3Ag-0.5Cu</li> </ul>
Terminal Strength	<ul style="list-style-type: none"> <li>- Without deformation cases</li> <li>- Impedance: within <math>\pm 30\%</math> of initial value</li> <li>- DC Resistance shall be satisfied</li> </ul>	<ul style="list-style-type: none"> <li>- Solder chip on PCB and applied 10N (1.02KgF) for 10 sec</li> </ul>
Temperature Cycle		<ul style="list-style-type: none"> <li>One cycle:</li> <li>- One cycle/step1: -55<math>\pm</math>3<math>^{\circ}</math>C for 30<math>\pm</math>3min</li> <li>step2: standard atmospheric conditions 5s or less</li> <li>step3: 125<math>\pm</math>2<math>^{\circ}</math>C for 30<math>\pm</math>3min</li> <li>step4: standard atmospheric conditions 5s or less</li> <li>- Total: 100cycles</li> <li>- Measured after exposure in the room condition for 24hrs</li> </ul>
Humidity Resistance	<ul style="list-style-type: none"> <li>- Appearance: No damage</li> <li>- Impedance: within <math>\pm 30\%</math> of initial value DC Resistance shall be satisfied</li> </ul>	<ul style="list-style-type: none"> <li>- Temperature: 60<math>\pm</math>2<math>^{\circ}</math>C</li> <li>- Relative Humidity: 90 ~ 95%</li> <li>- Applied Current: Rated Current(maximum value)</li> <li>- Time: 1008<math>\pm</math>12hrs</li> <li>- Measured after exposure in the room condition for 24hrs</li> </ul>
High Temperature Resistance		<ul style="list-style-type: none"> <li>- Temperature: 125<math>\pm</math>2<math>^{\circ}</math>C</li> <li>- Applied Current: Rated Current(maximum value)</li> <li>- Time: 1008<math>\pm</math>12hrs</li> <li>- Measured after exposure in the room condition for 24hrs</li> </ul>
Low Temperature Storage Life Test		<ul style="list-style-type: none"> <li>- Temperature: -55<math>\pm</math>2<math>^{\circ}</math>C</li> <li>- Time: 1008<math>\pm</math>12hrs</li> <li>- Measured after exposure in the room condition for 24hrs</li> </ul>
Thermal Shock		<ul style="list-style-type: none"> <li>- -55<math>^{\circ}</math>C~125<math>^{\circ}</math>C kept stabilized for 30 minutes each for 100 cycles</li> <li>- Measured after exposure in the room condition for 24hrs</li> </ul>

- Operating Temperature: -55 $^{\circ}$ C ~ 125 $^{\circ}$ C
- Storage Temperature: 15~28 $^{\circ}$ C ; Humidity < 80%RH



## PACKAGING

### - Reel Specifications

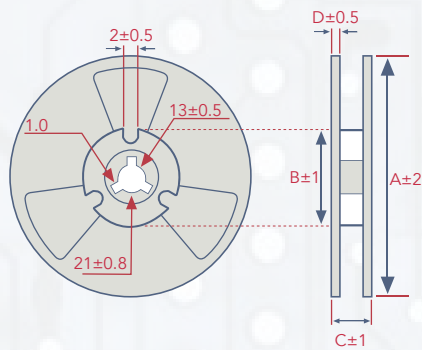

### - Tape Specifications

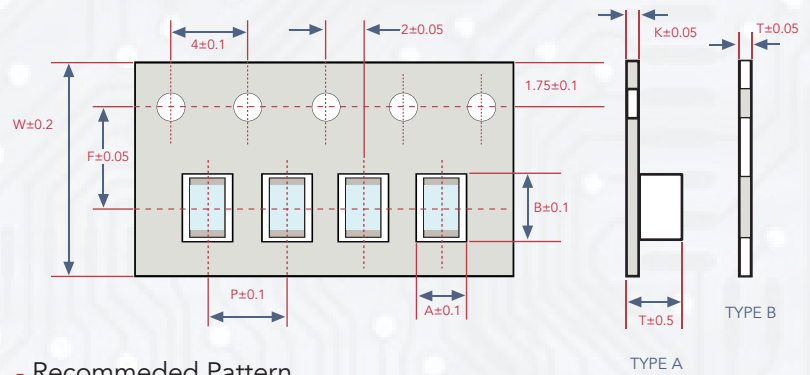

### - Tape Material

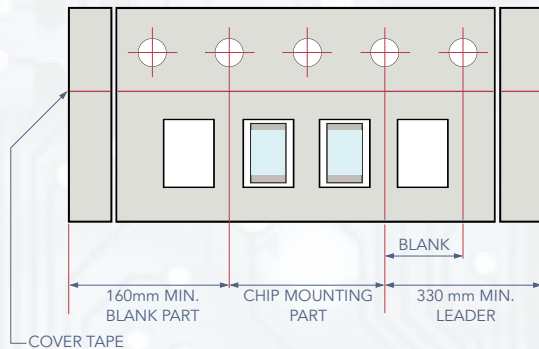

### - Recommended Pattern

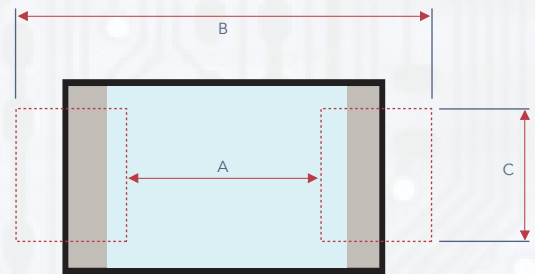

Unit : mm

TYPE	TAPE DIMENSIONS								REEL DIMENSIONS				RECOMMENDED PATTERN			QUANTITY (EA)
	A	B	T	W	P	F	K	TAPE TYPE	A	B	C	D	A	B	C	
FB060303	0.38	0.68	1.10	8.0	2.0	3.5	-	B	178	60	10	2	0.25	0.69	0.32	15000
FB100505	0.65	1.15	0.80	8.0	2.0	3.5	-	B	178	60	10	2	0.50	2.10	0.55	10000
FB160808	1.10	1.90	1.10	8.0	4.0	3.5	-	B	178	60	10	2	0.60	2.60	0.80	4000
FB201209	1.55	2.30	1.20	8.0	4.0	3.5	-	B	178	60	10	2	0.66	3.23	1.47	4000
FB321611	1.90	3.50	1.40	8.0	4.0	3.5	0.2	A	178	60	10	2	2.20	4.40	2.06	3000
FB321616	1.88	3.64	1.90	8.0	4.0	3.5	0.2	A	178	60	10	2	2.20	4.2-5.2	1.2	2000
FB322513	2.90	3.60	1.70	8.0	4.0	3.5	0.2	A	178	60	10	2	2.13	4.06	2.74	2000
FB451616	2.90	4.90	1.40	12	4.0	5.5	0.3	A	178	60	14	2	2.70	5.70	2.24	2000
FB453215	3.60	4.90	2.05	12	8.0	5.5	0.3	A	178	60	14	2	2.57	5.90	4.22	1000

\*NOTE: Tape Type B denotes cardboard | Tape Type A denotes embossed plastic type

## SOLDERING CONDITION

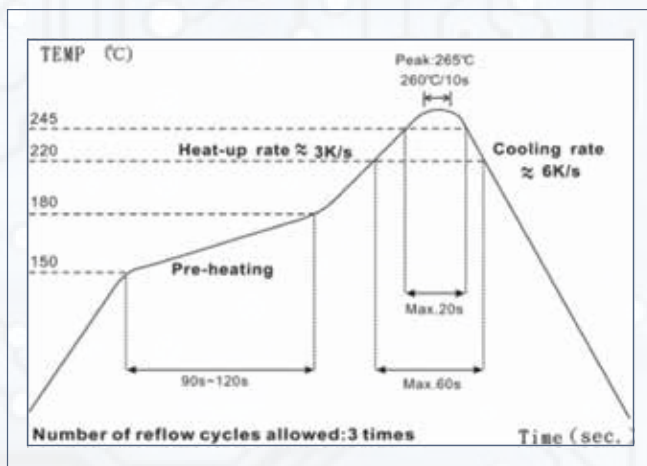

### IR Reflow Soldering

(1) Time of IR reflow soldering at maximum temperature point 260°C zzz: 10s

(2) Time of soldering iron at maximum temperature point 280°C : 3s

